

Relievverzierte Terra-Sigillata M 1:2

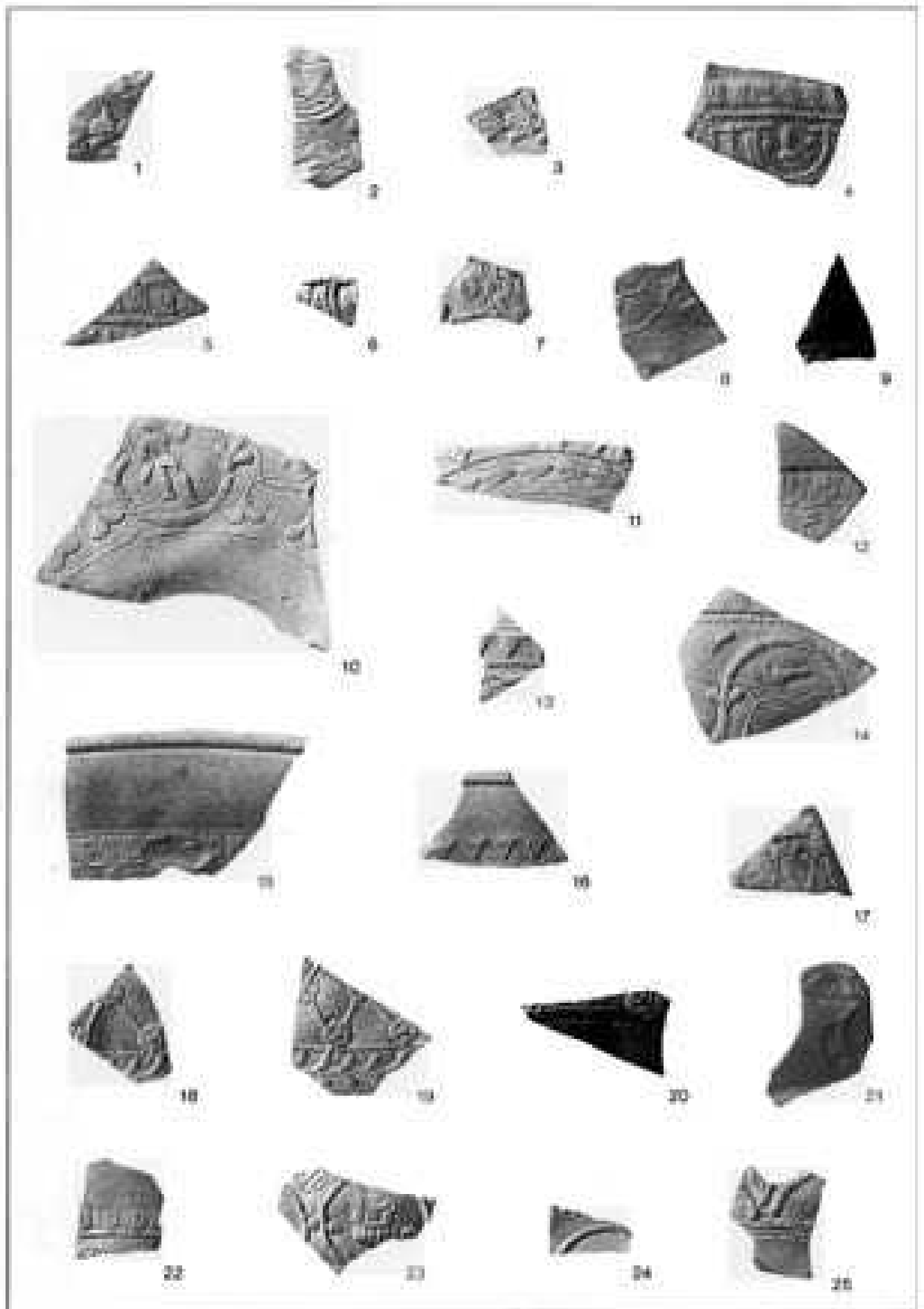

Reliefverzierte Terra Sigillata M. 1-2

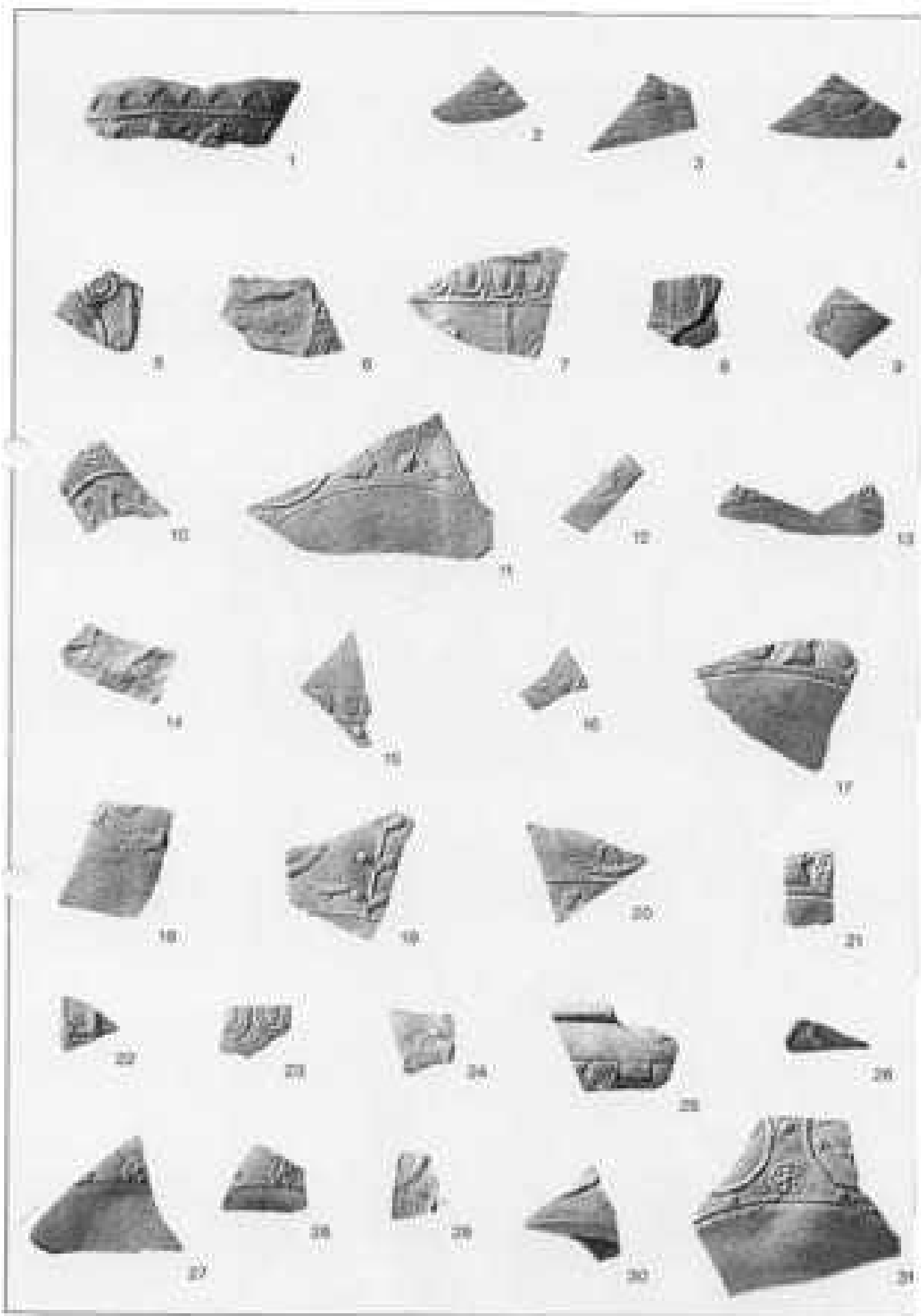



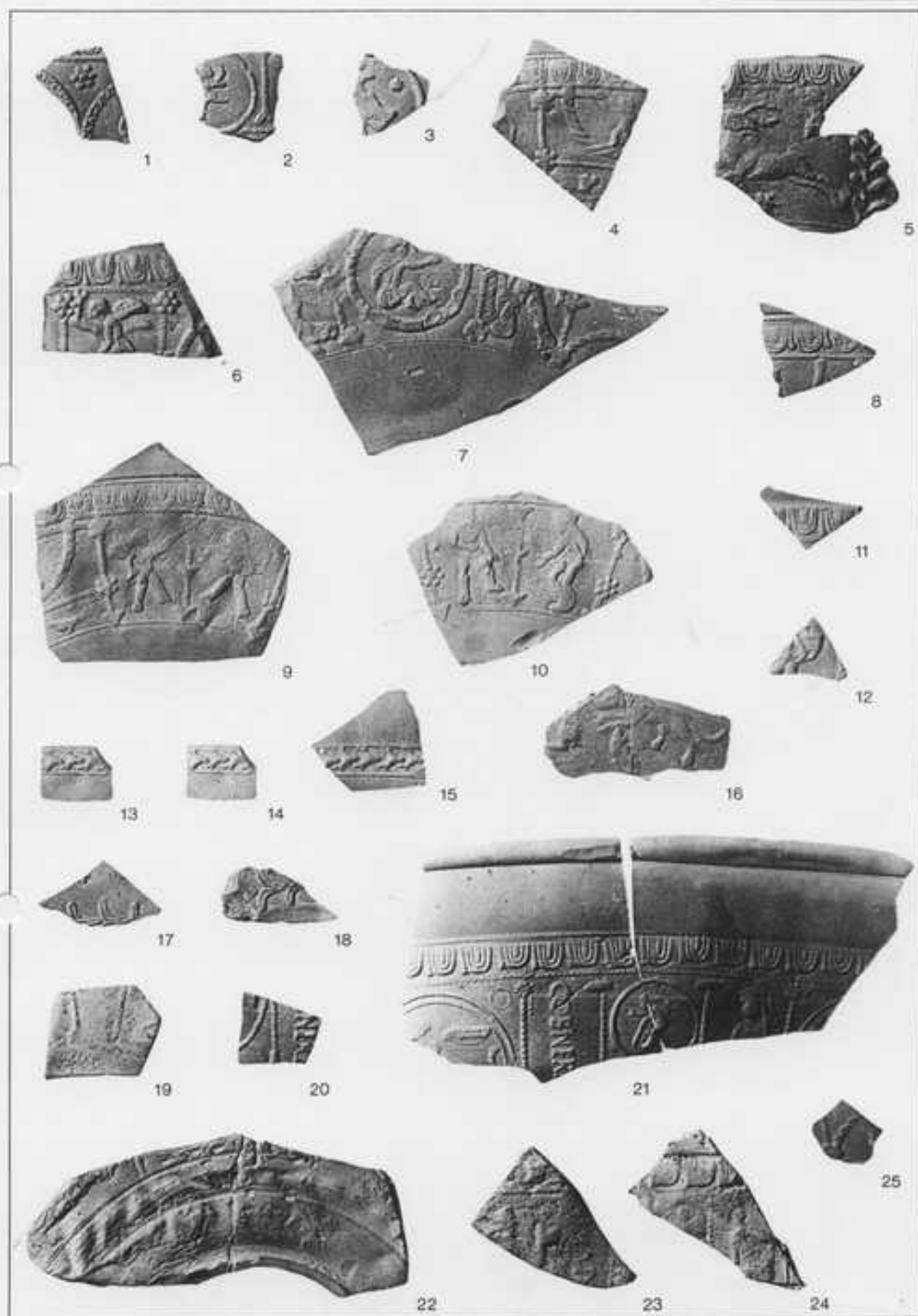

Reliefverzierte Terra Sigillata M. 1:2

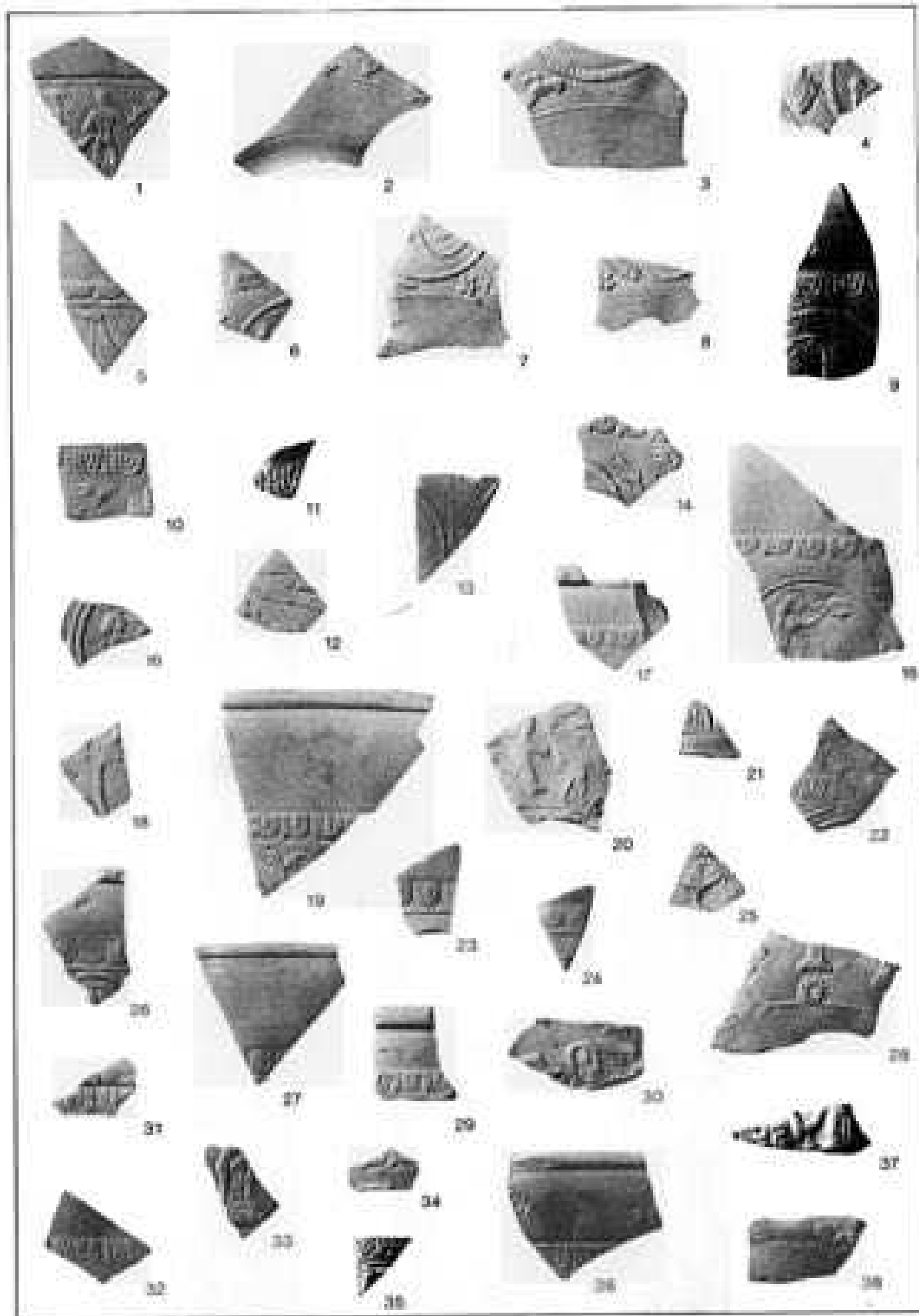

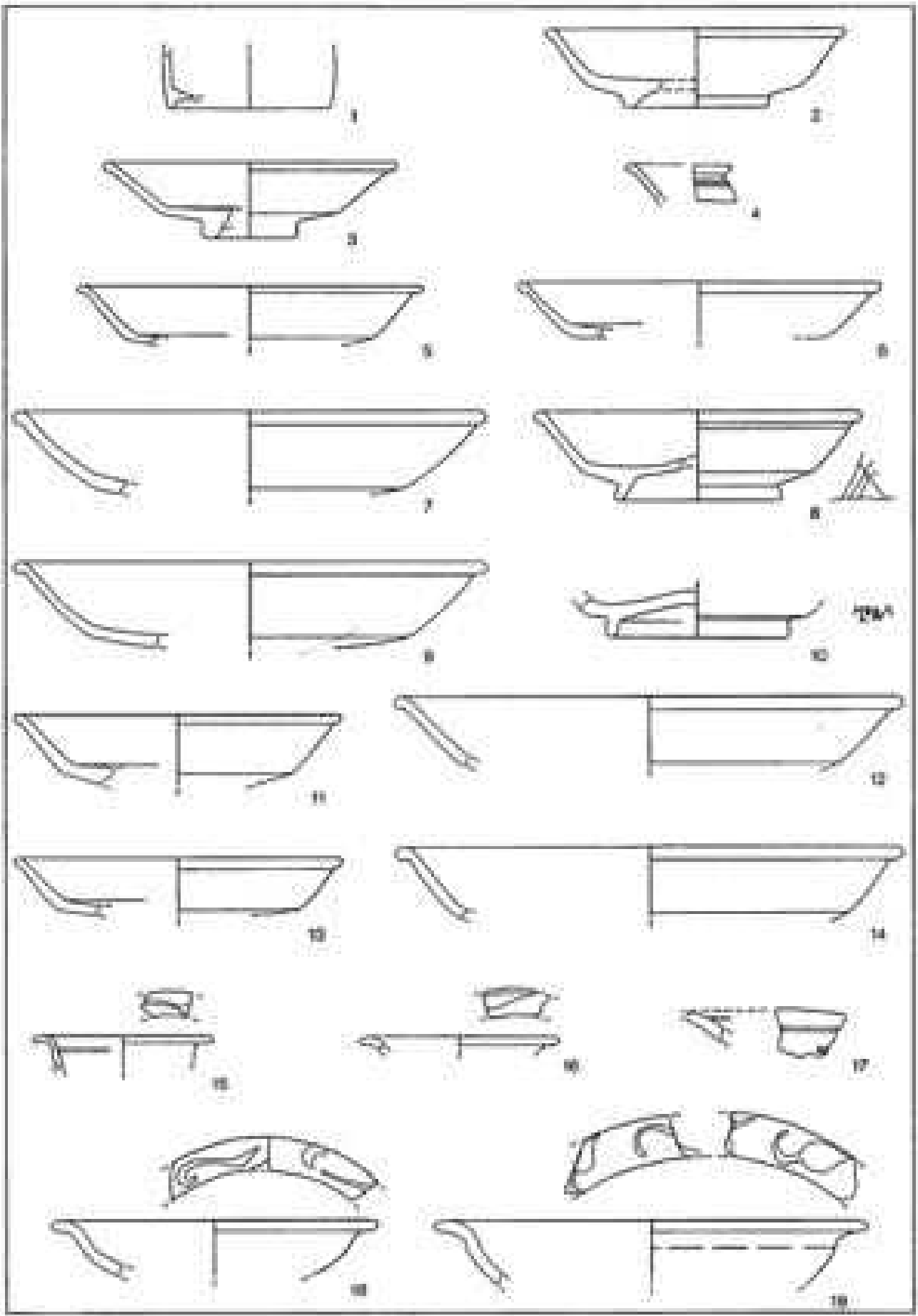

Gatte Terra Sigillata. M. 1:3.

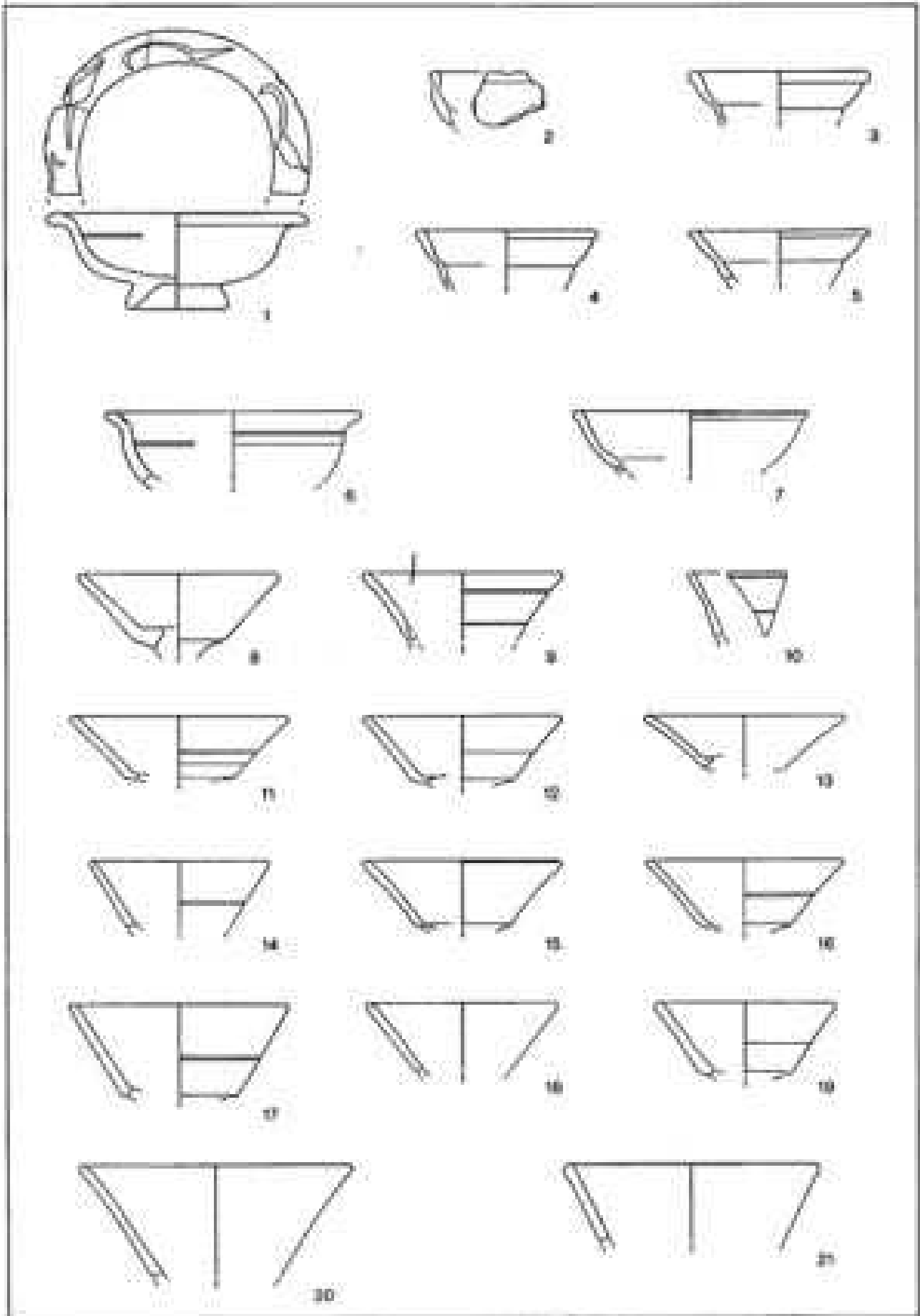

Glatta Terra Sigillata. M 1/3.

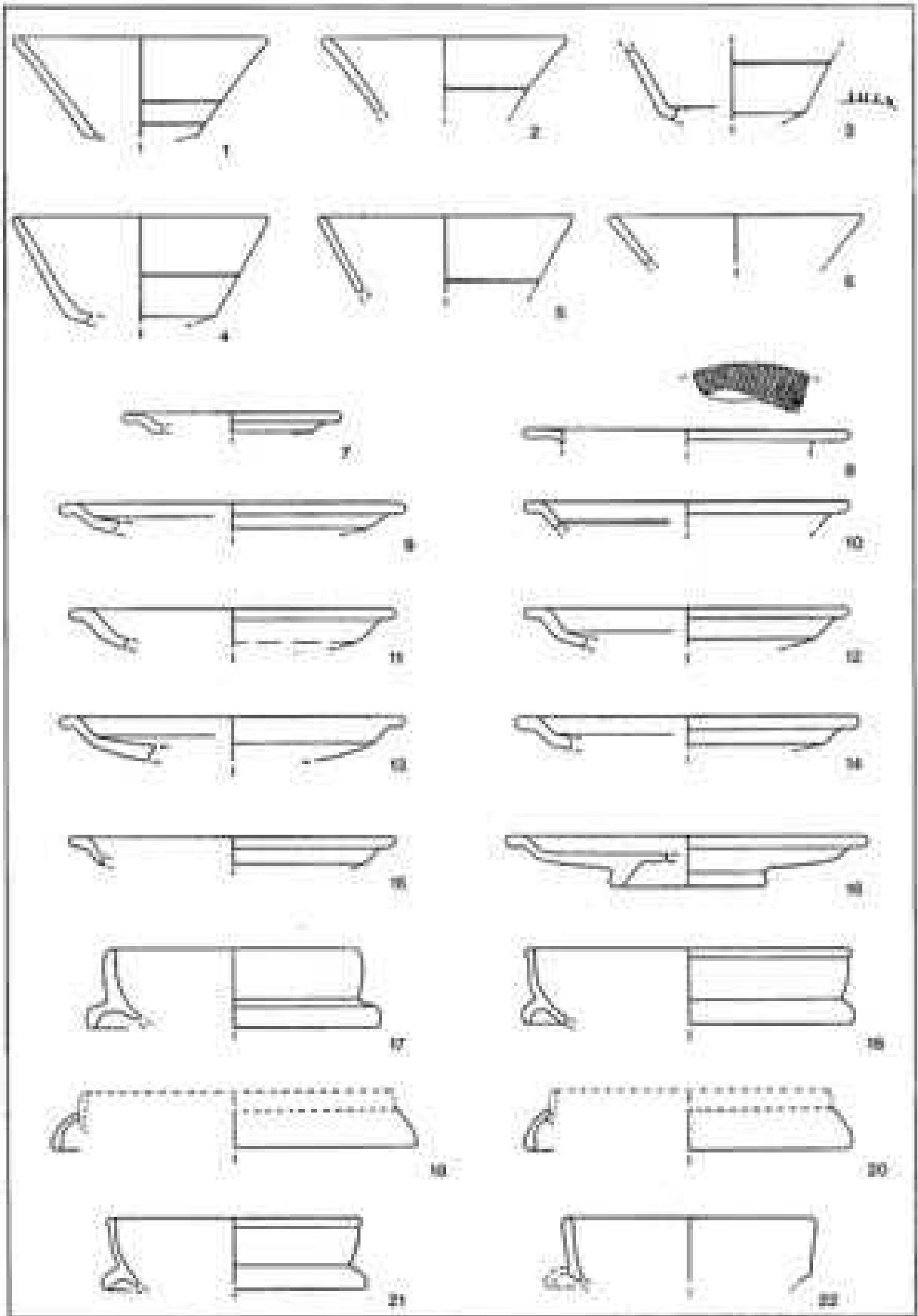

Glaso Terra Sigillata. M. 13.

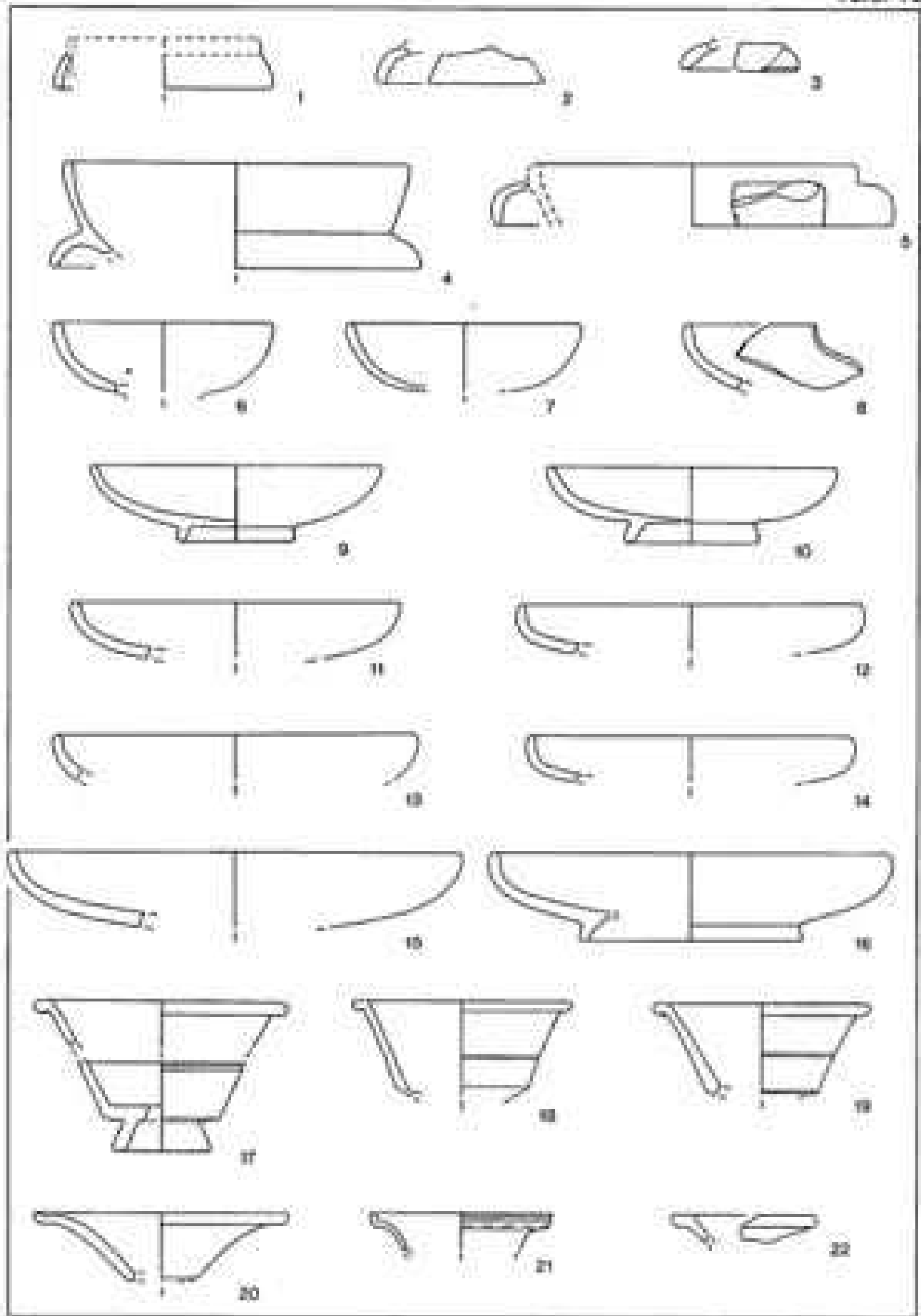

Glasco Terra Sigillata, M. 113.

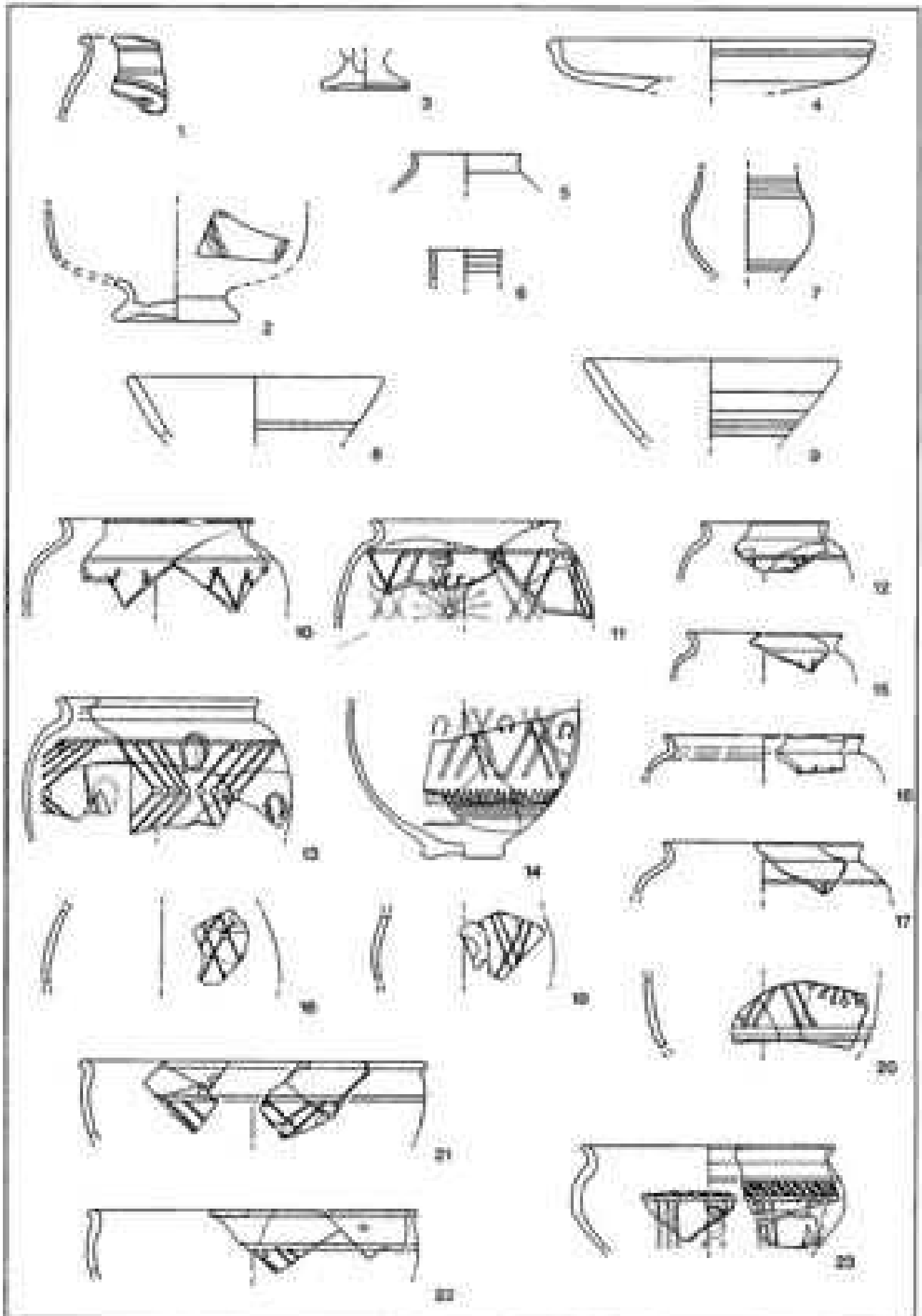

1-7 Glatte Terra Sigillata, 8, 9 Terra Sigillata Imitation, 10-23 Geometrisch verzierte Glanztonware (flache Ware). M. 1:3.

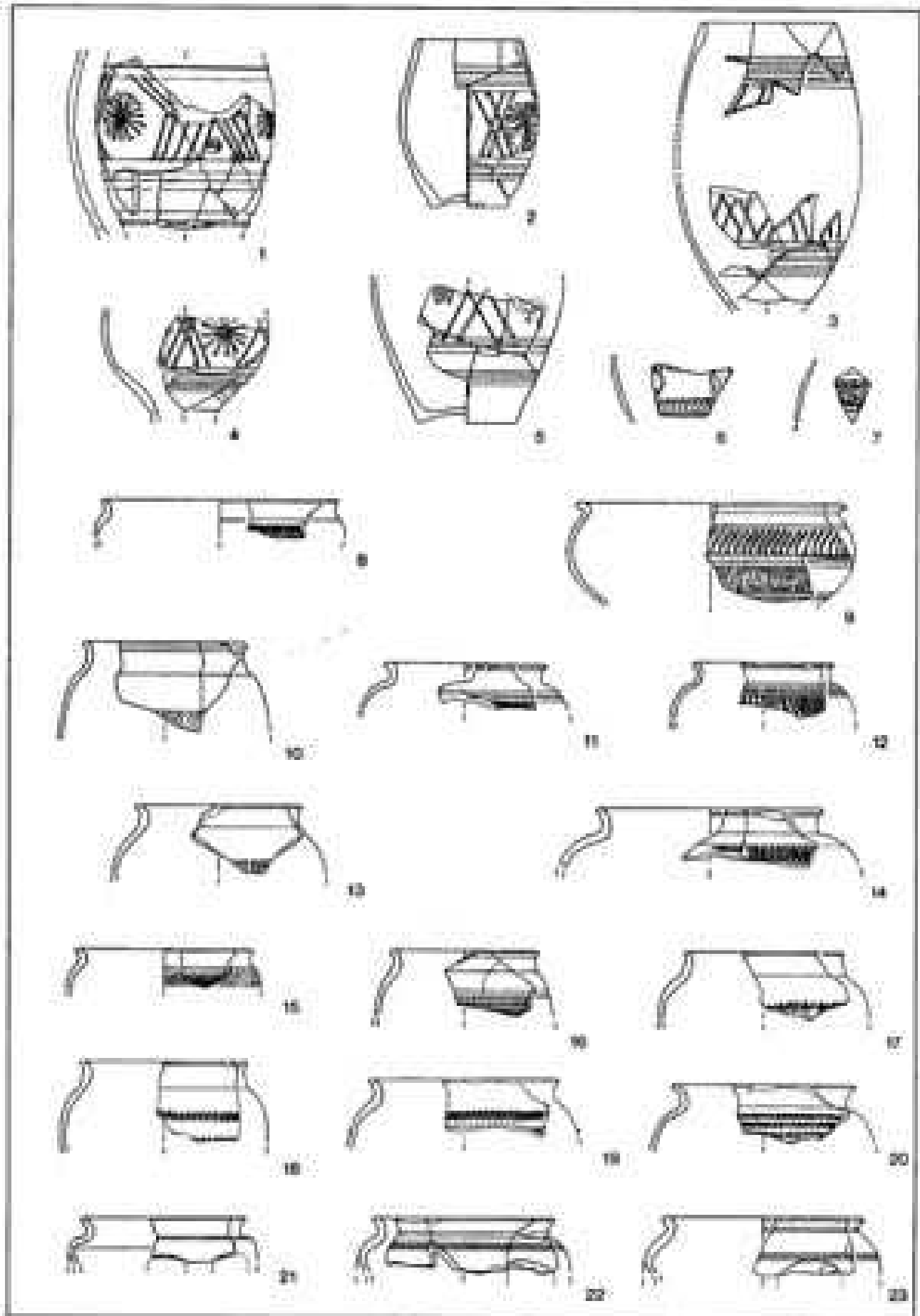

1-20 Geometrisch verzierte Glasurtonware (Russische Ware), 21-23 Faltenbecher, M. 1:3.

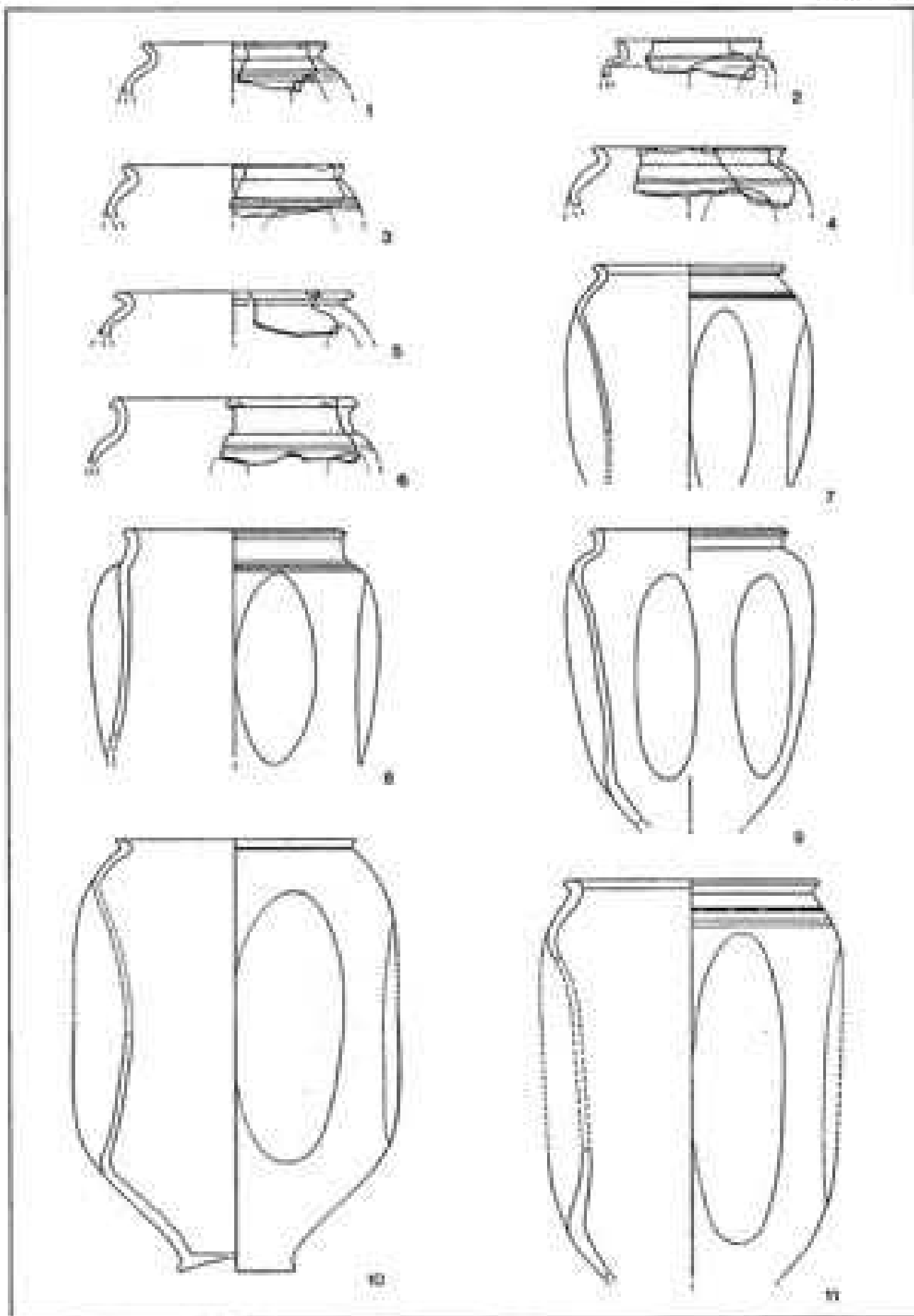

Falterbecher, M. 1:3.

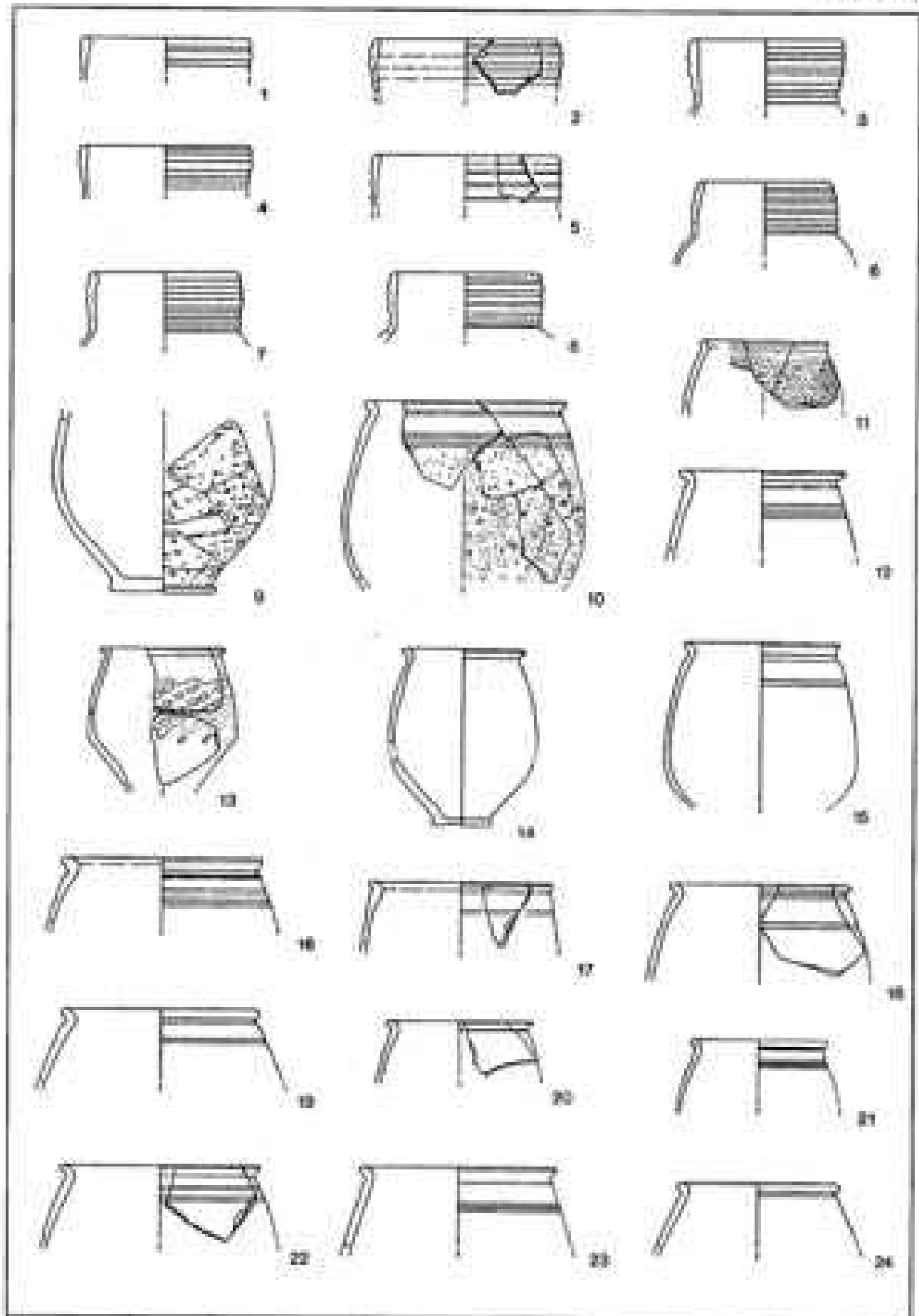

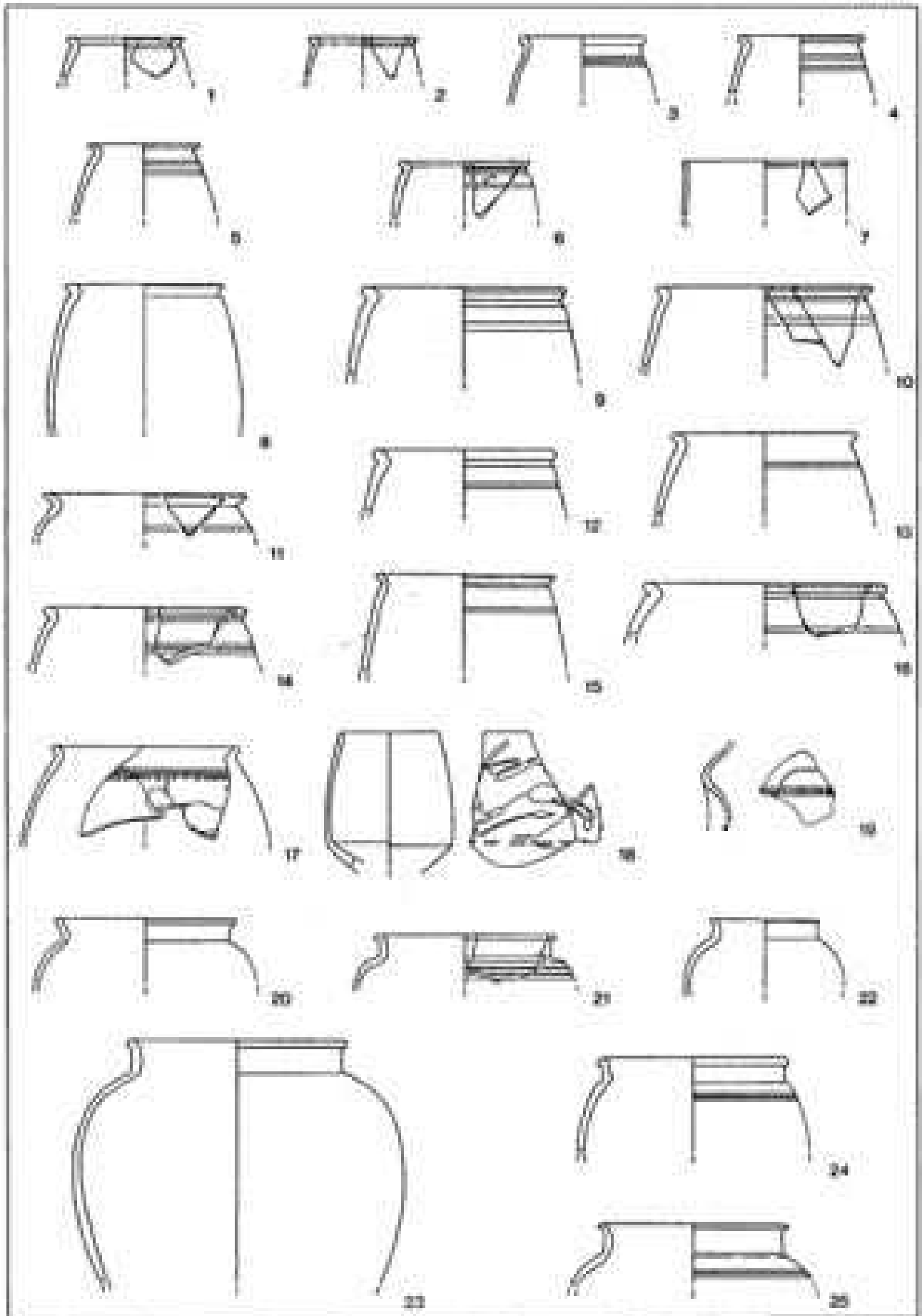

Becher, M. 1-3.

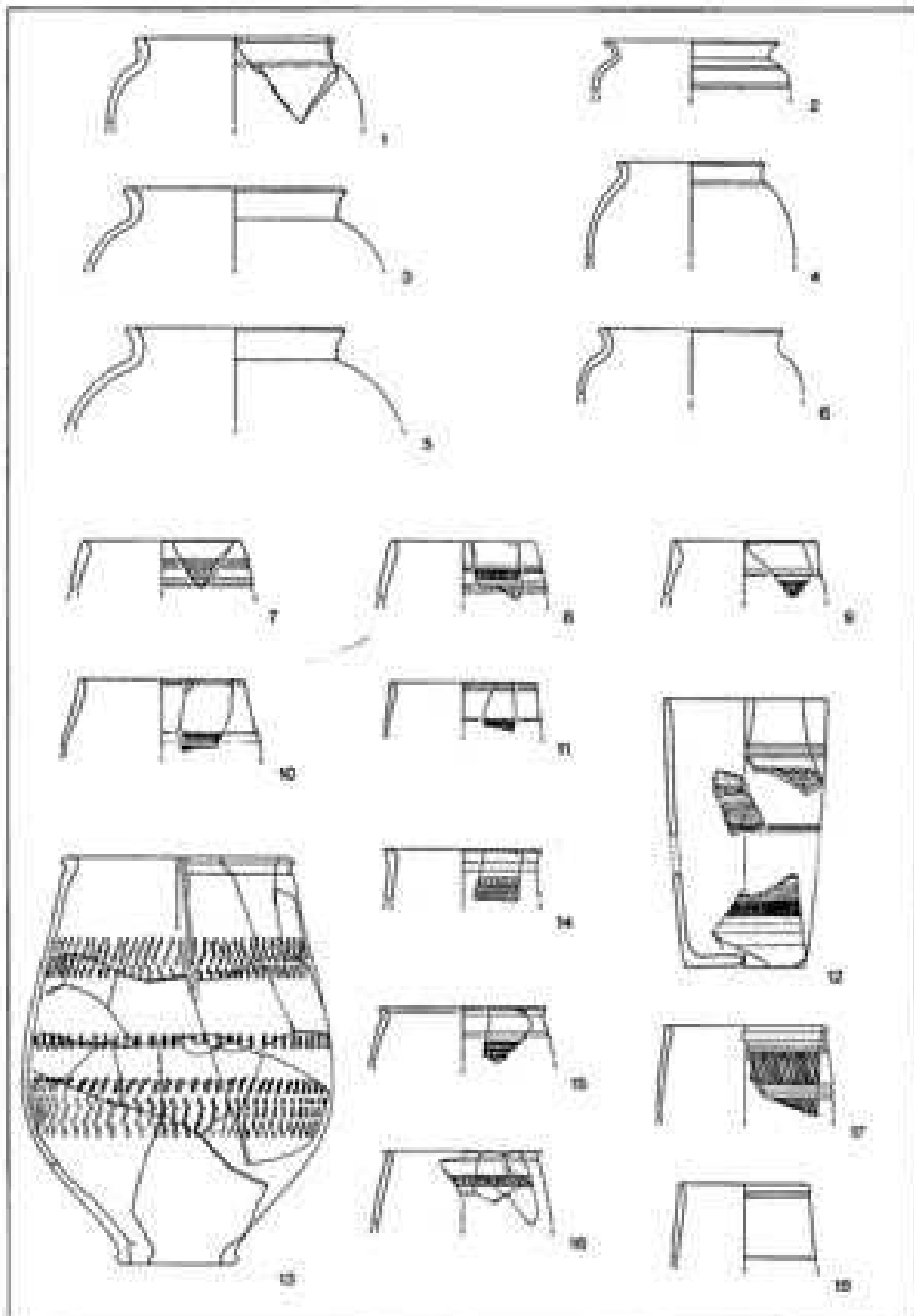

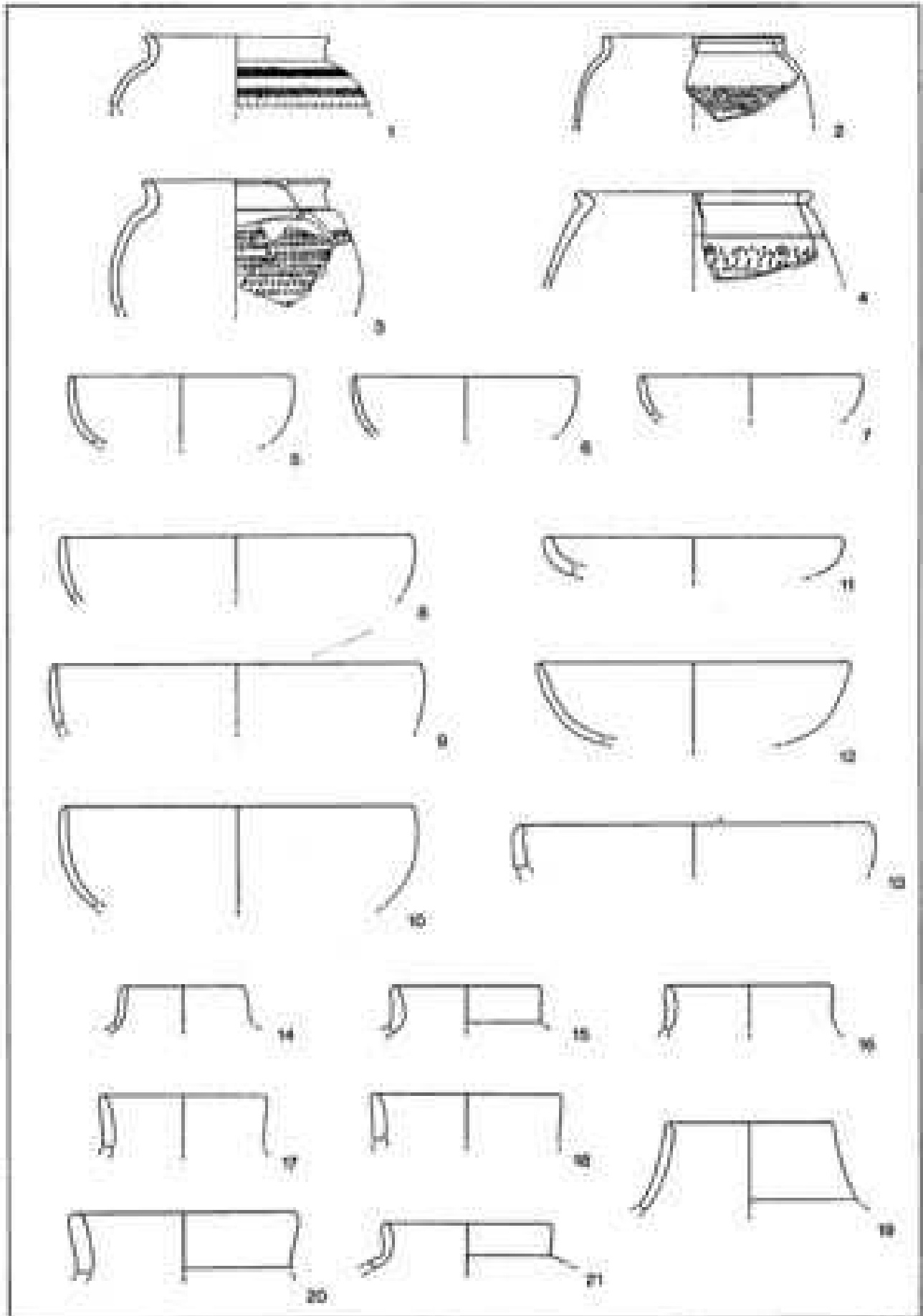

1-4 Buxter, 5-21 Terra Nigra. M. 1:3.

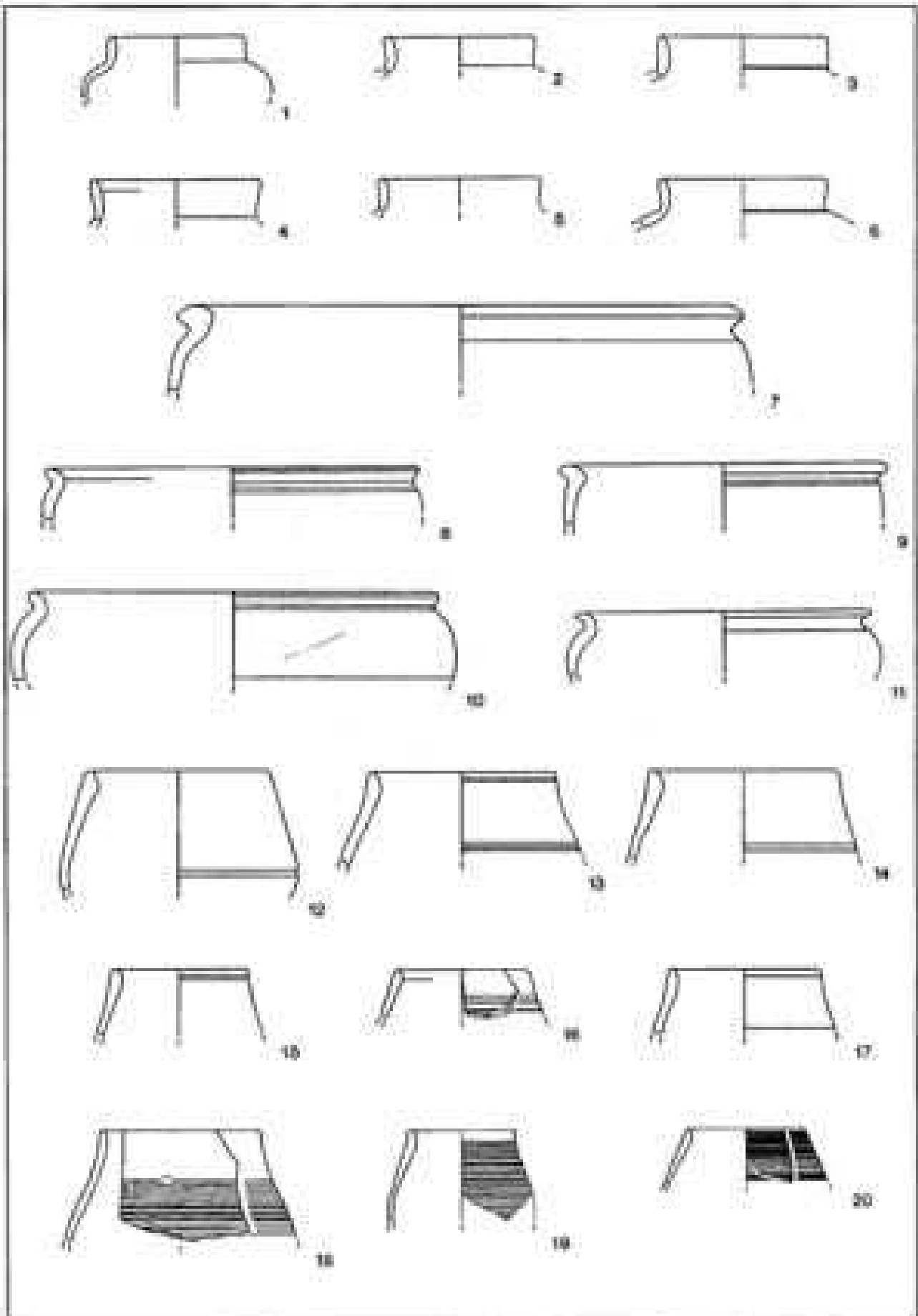

Terra Nigra. M. 113.

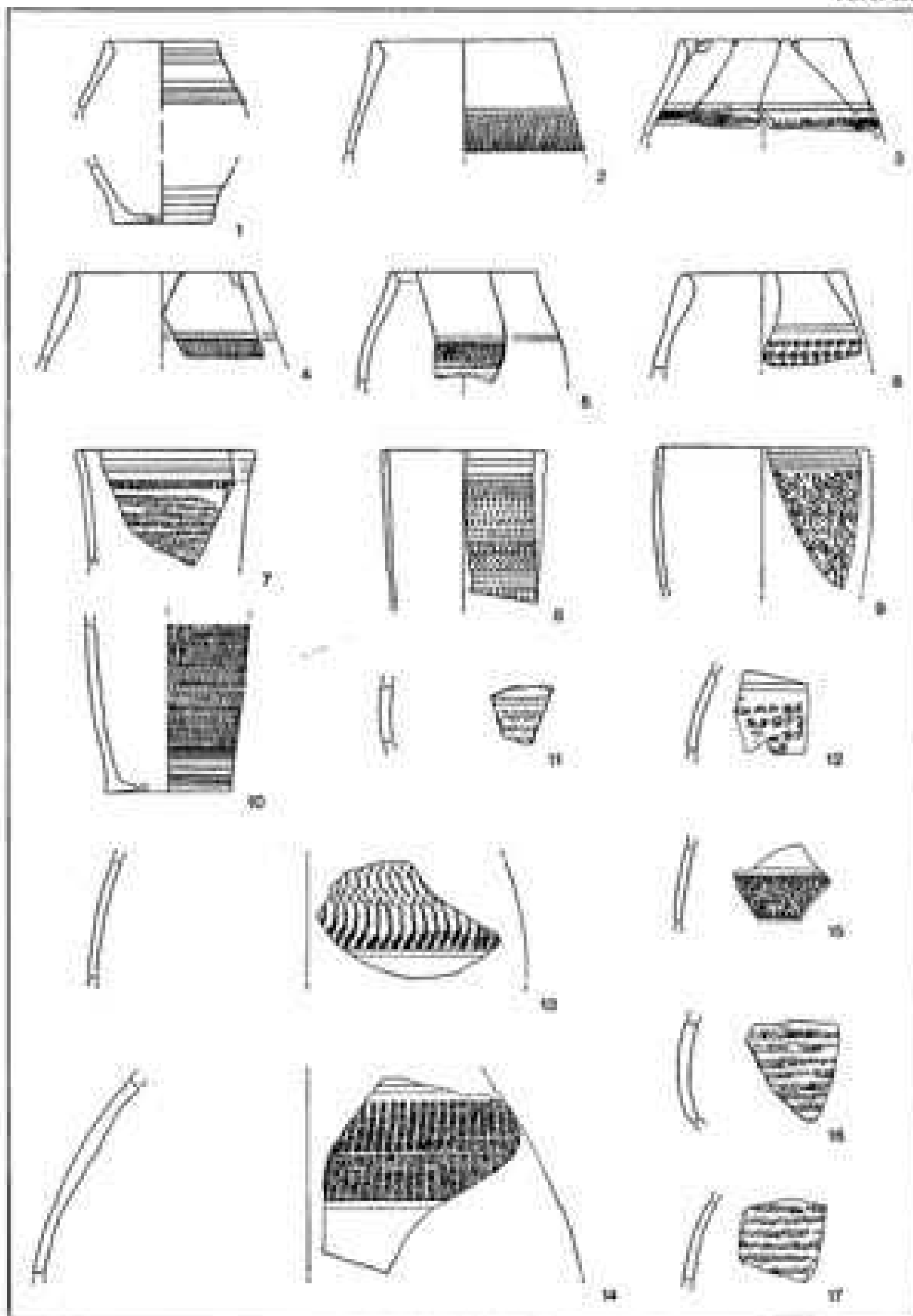

Testa Nigra. M. 113.

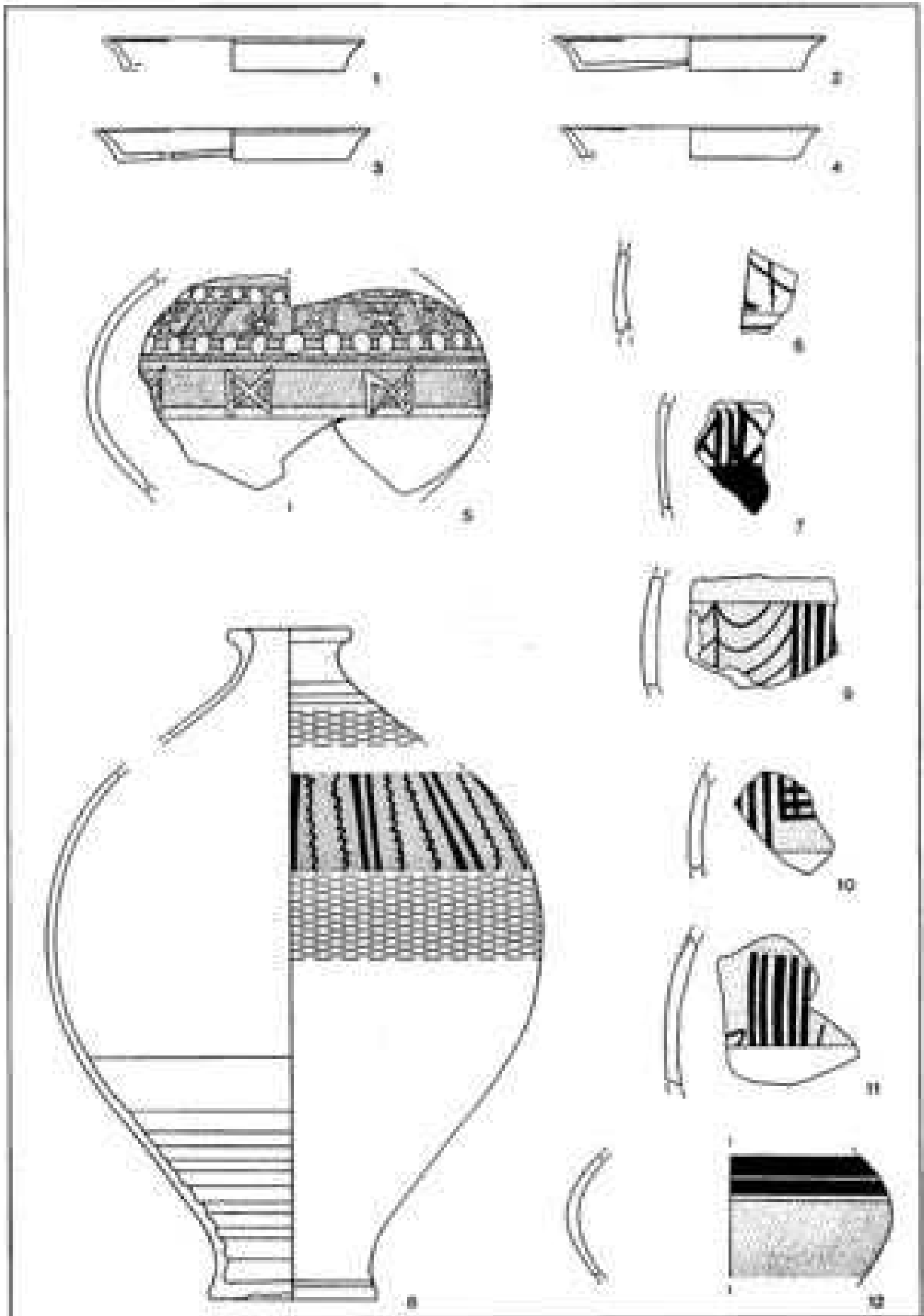

1-4 Terra Nigra, 5-12 Samalite Fluchten. 8 M. 1:4, 1-7, 9-12 M. 1:3.

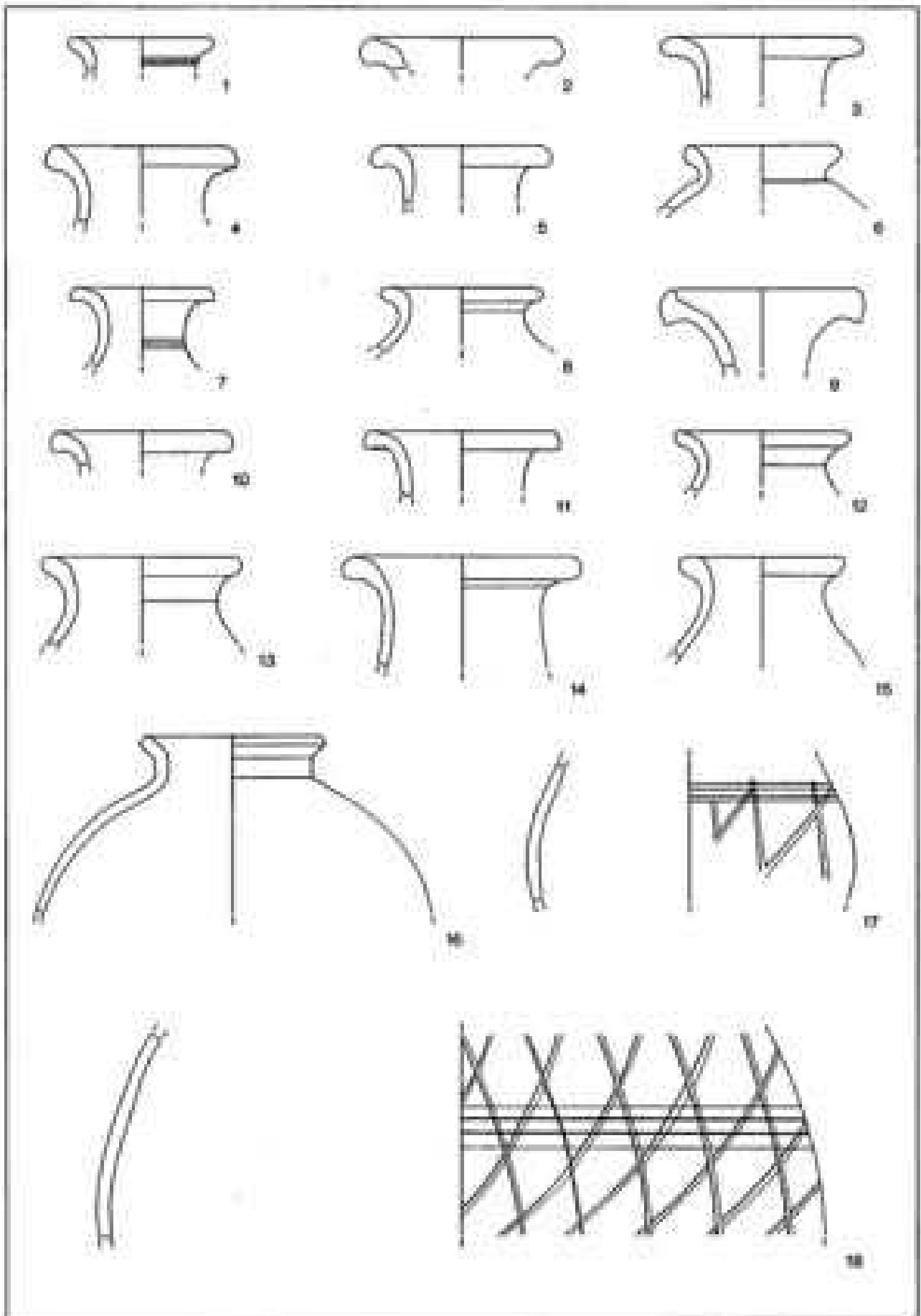

Flaschen. M. 1-3.

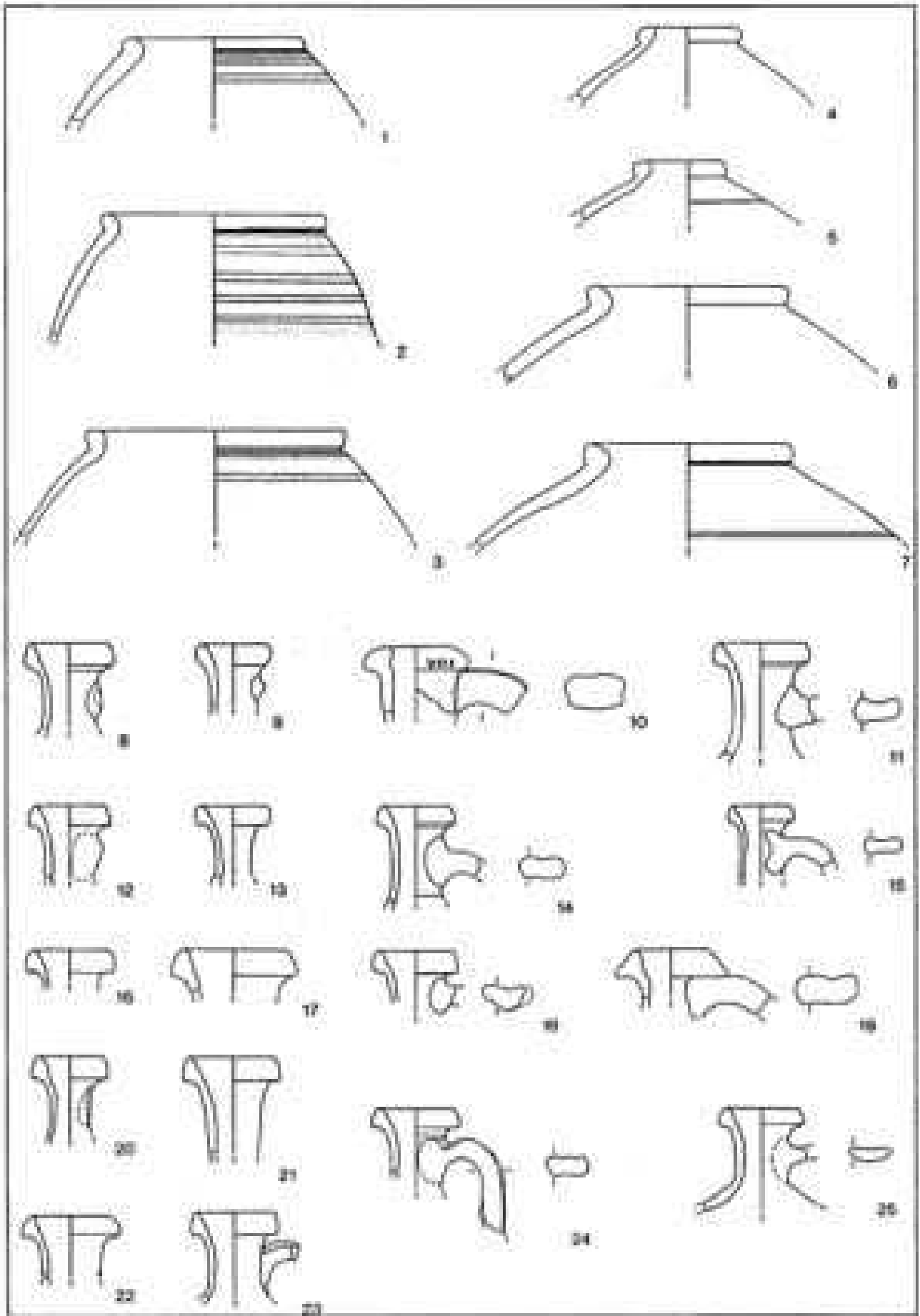

1-7 Törnen, 8-25 Einherkekrüge. M. 1:3.

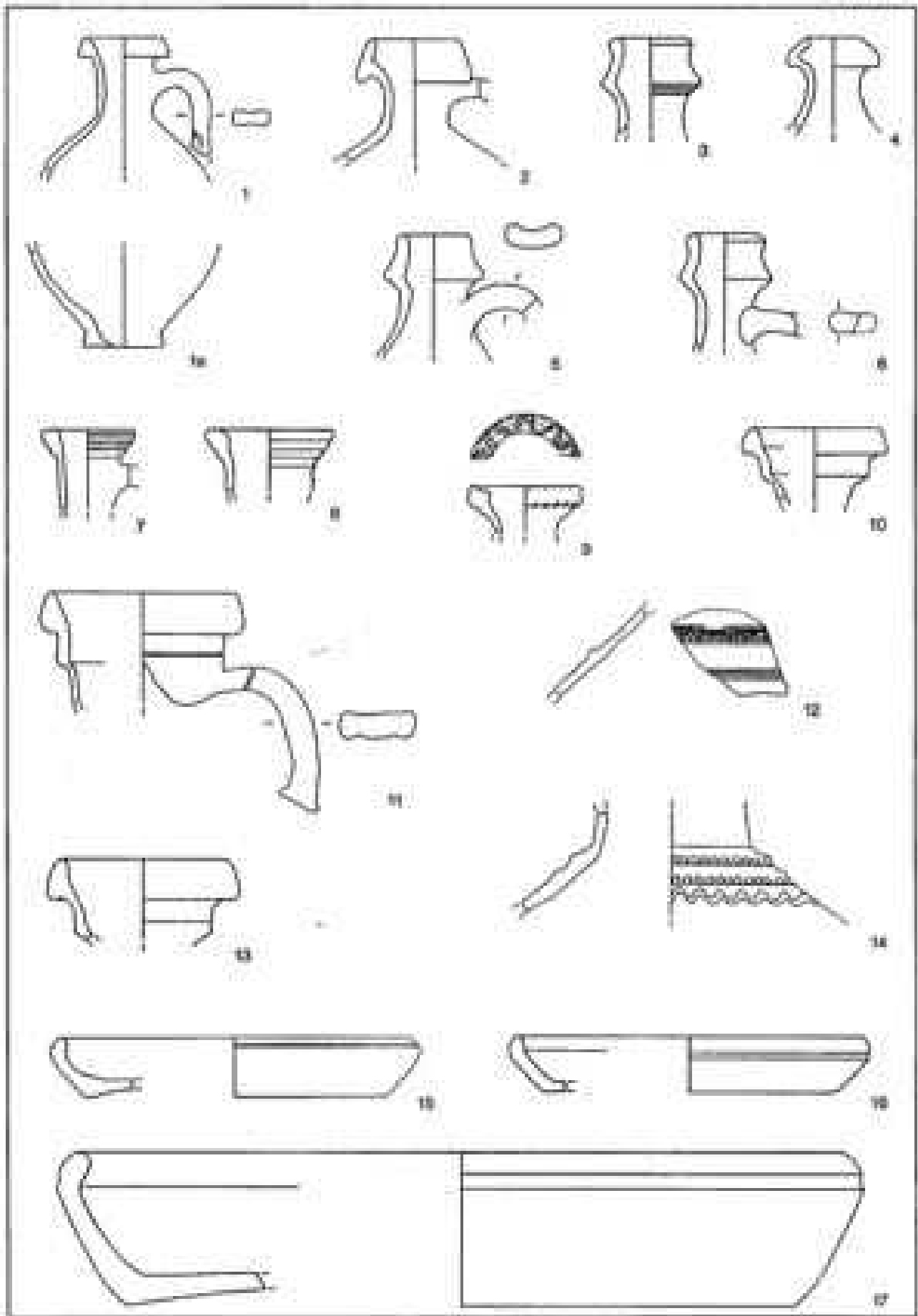

1-9 Einhandelkrüge, 10-14 Zwoihandekrüge, 15-17 Teller.
M. 1:3.

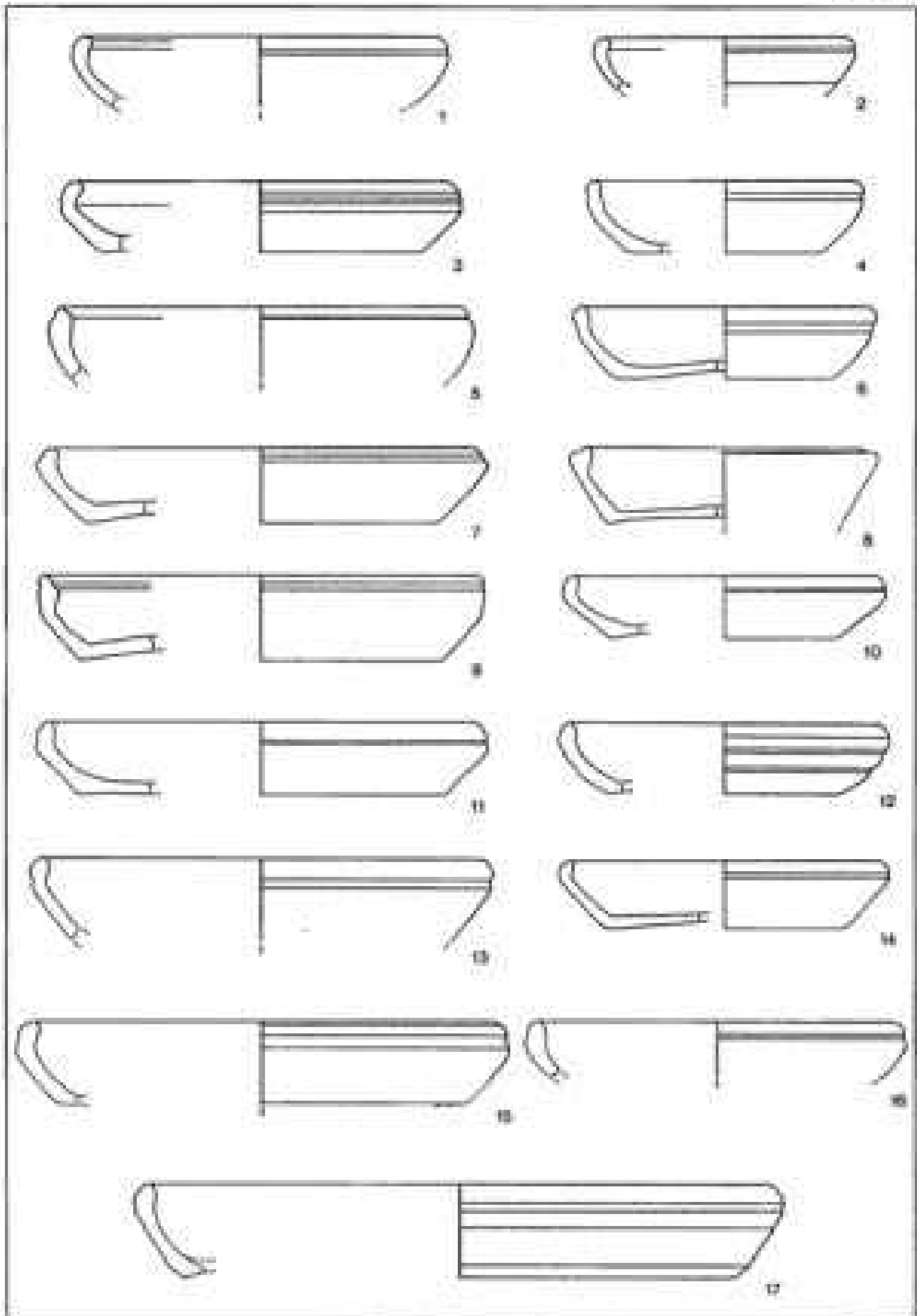

Tafel (Typ 11. M. 1.2.)

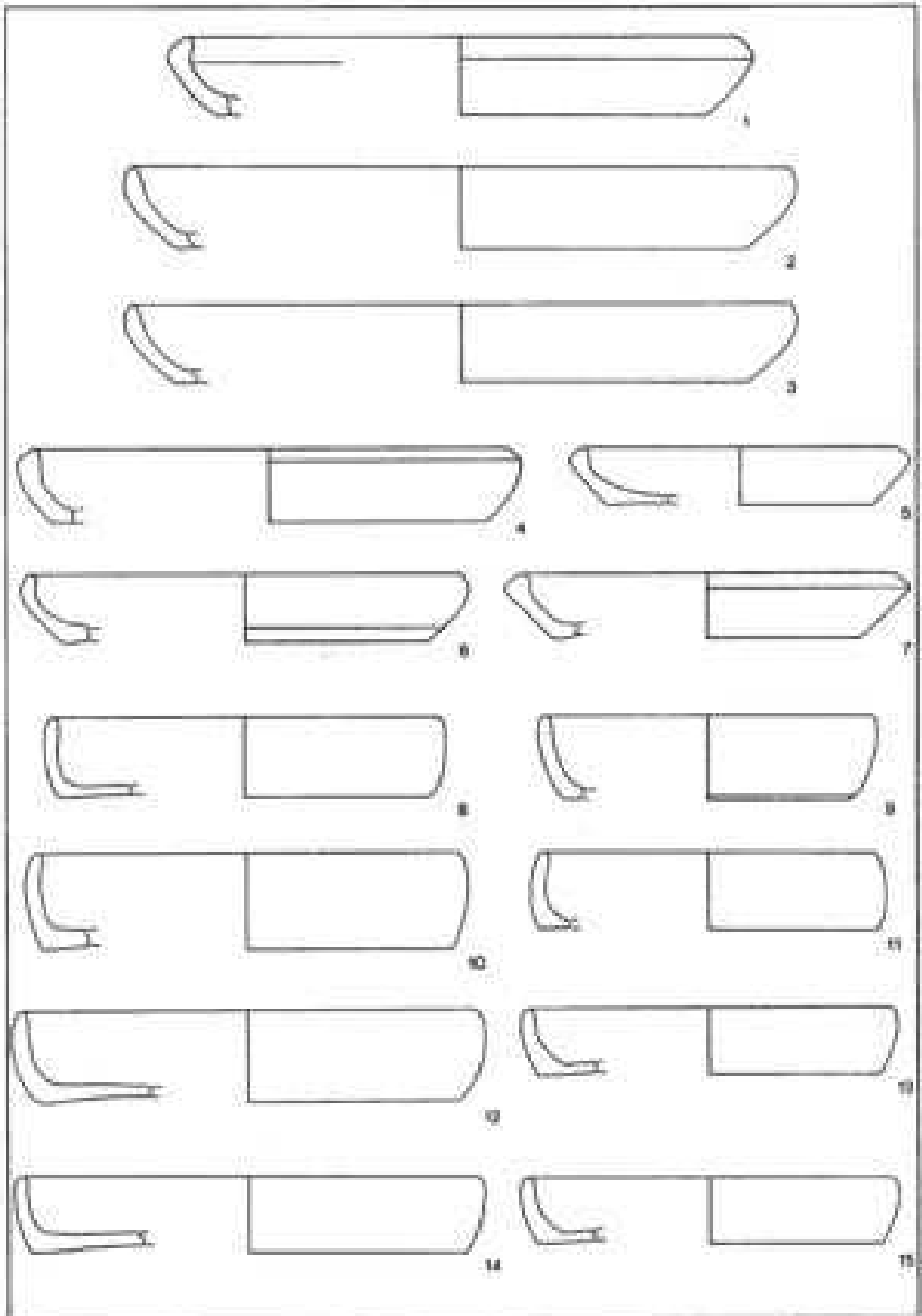

1-7 Teller (Typ 2), 8-15 Teller (Typ 3). M. 1-3.

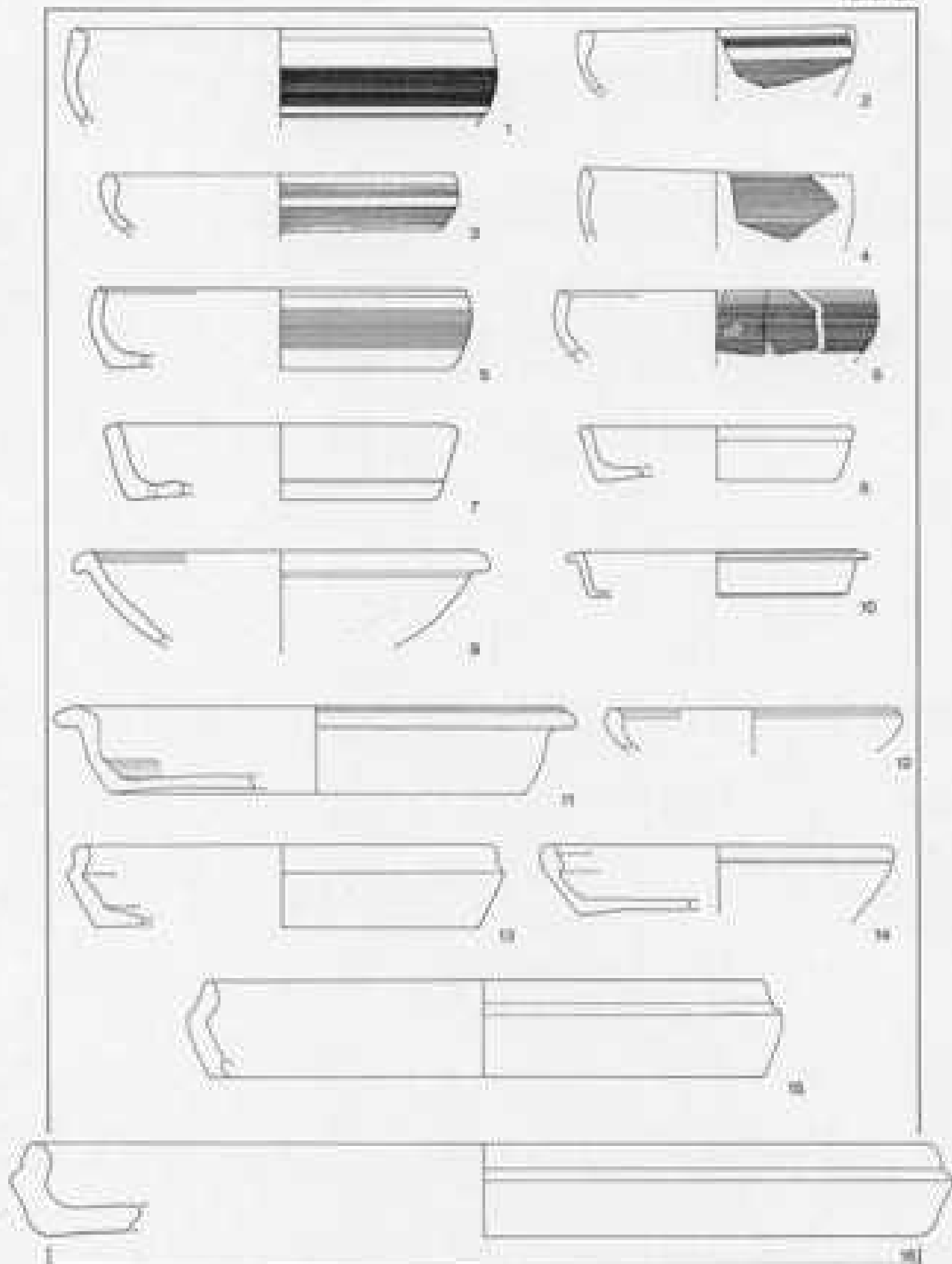

1-6 Teller (Typ 4), 7-16 Teller (Sonder- und Einzelformen).
M. 1:2.

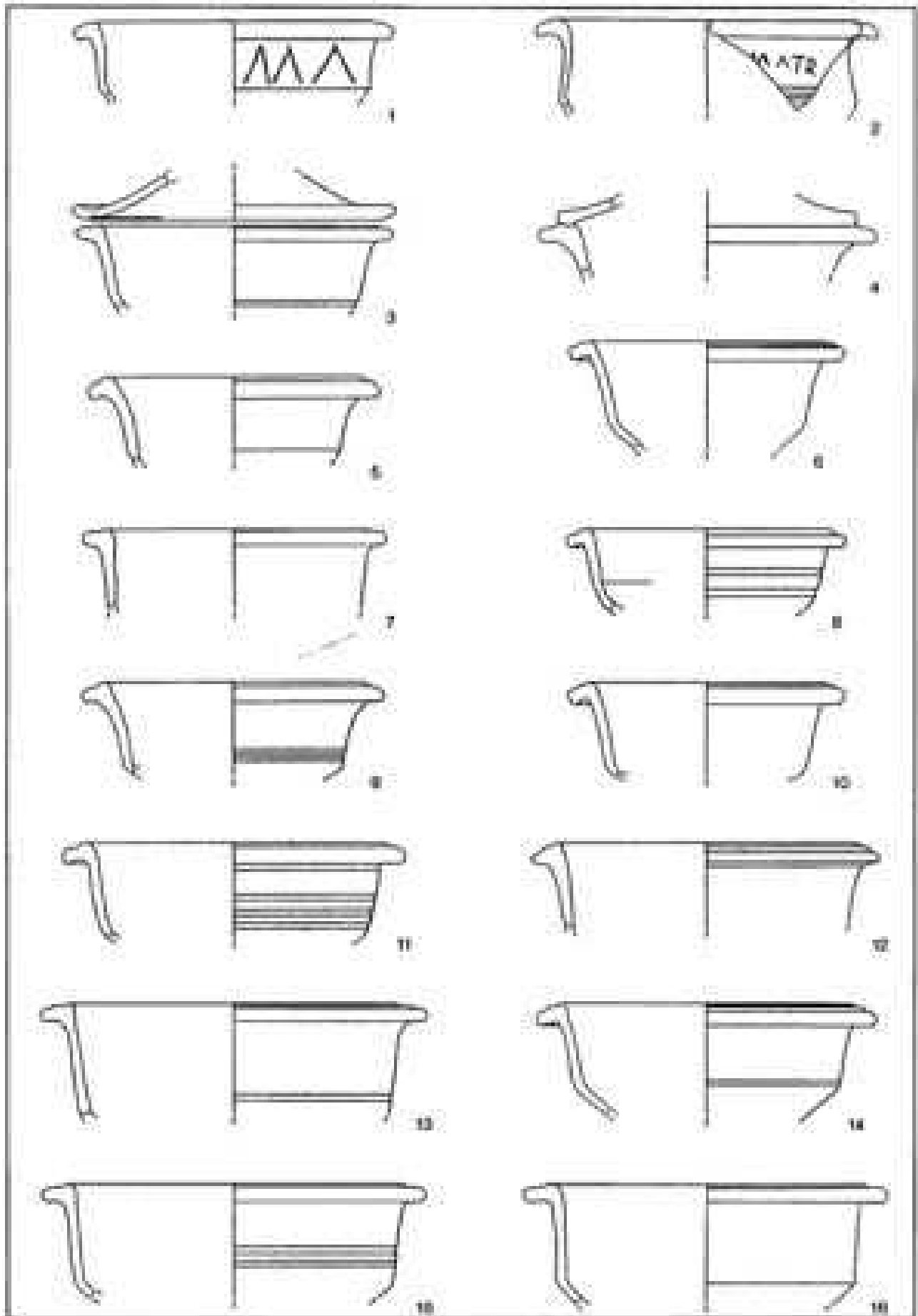

Schüssel (Typ 11, M. 113)

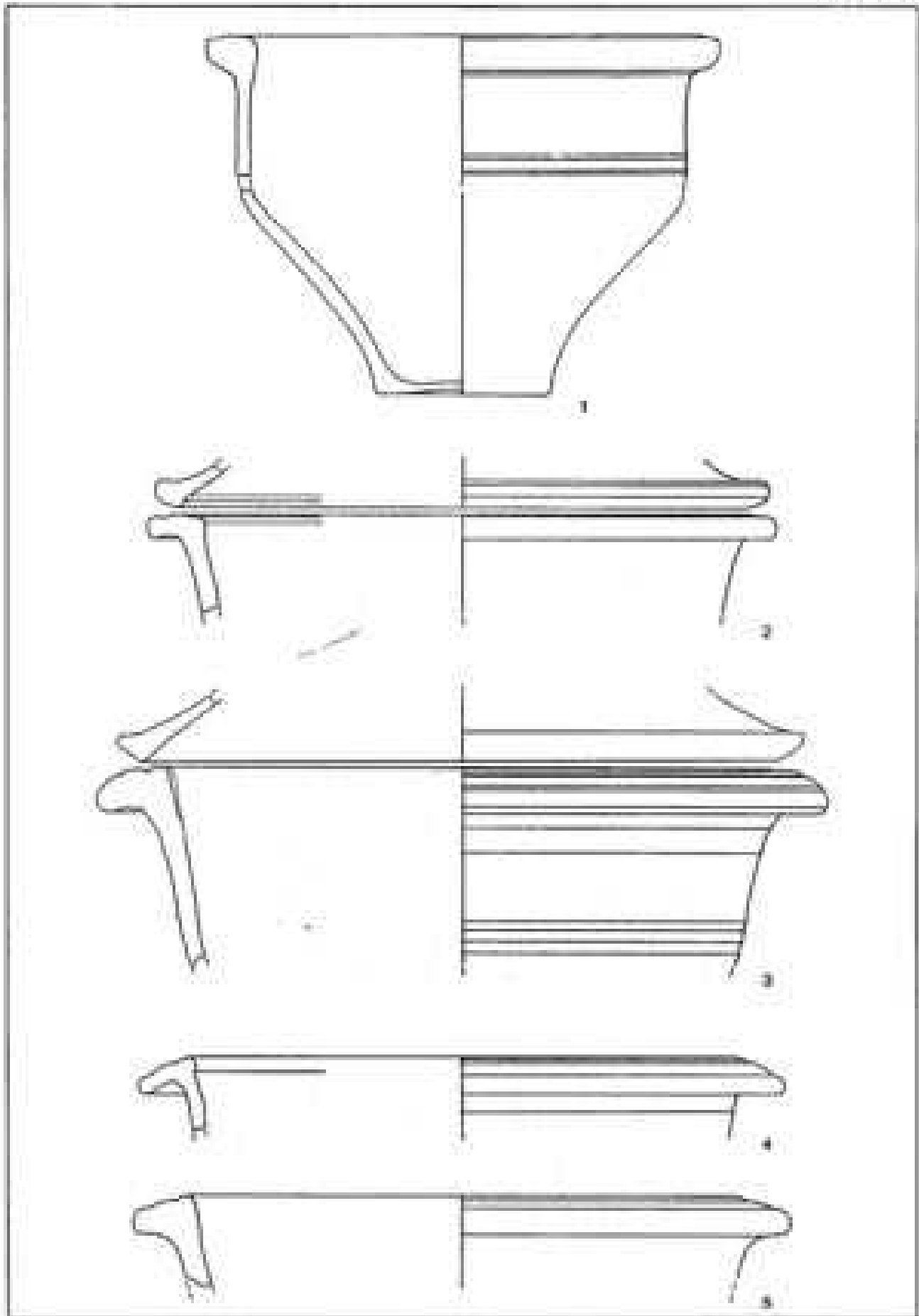

Schüssel (Typ 21, M. 1:3)

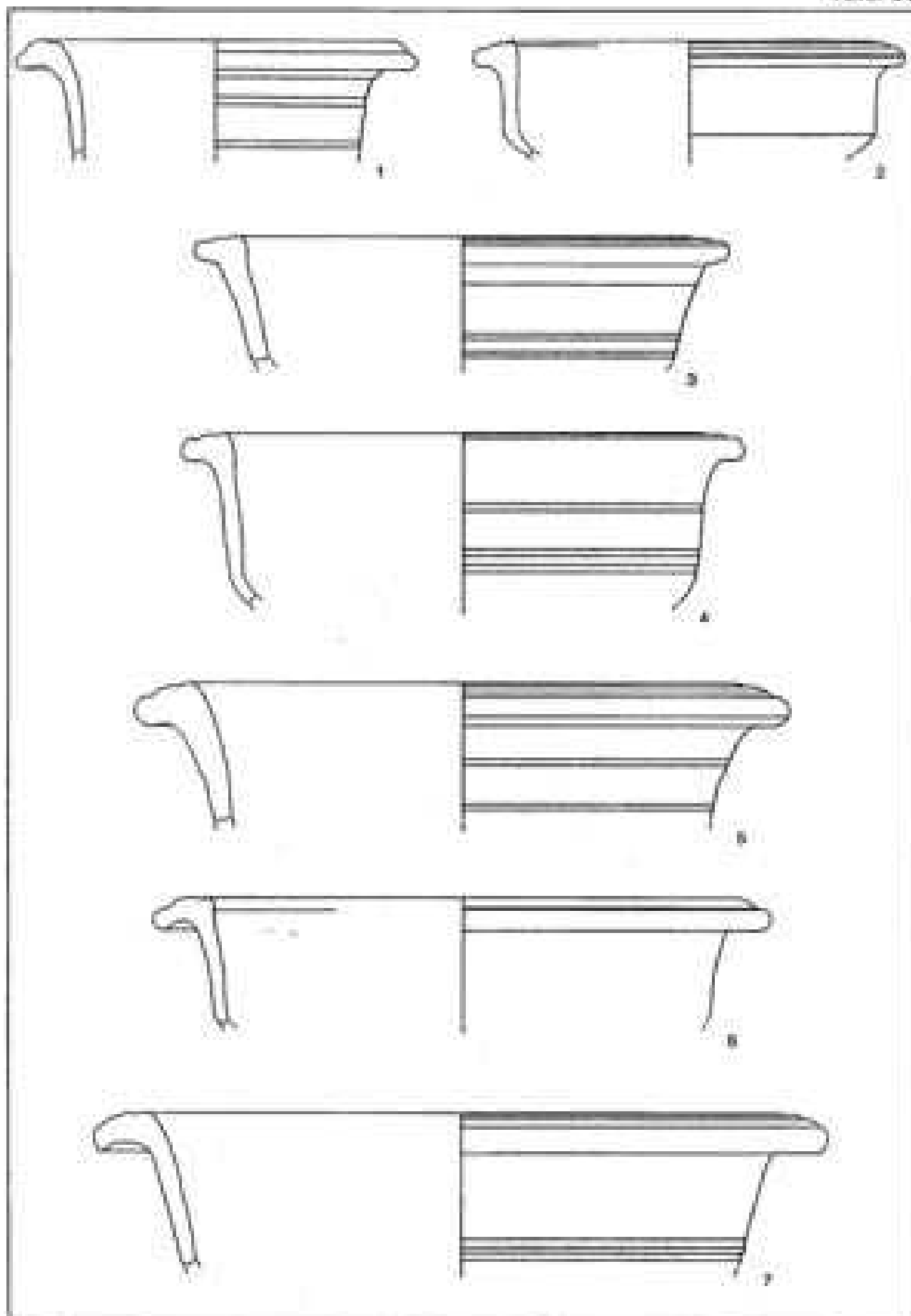

Schlüssel (Typ Zi. M. 113)

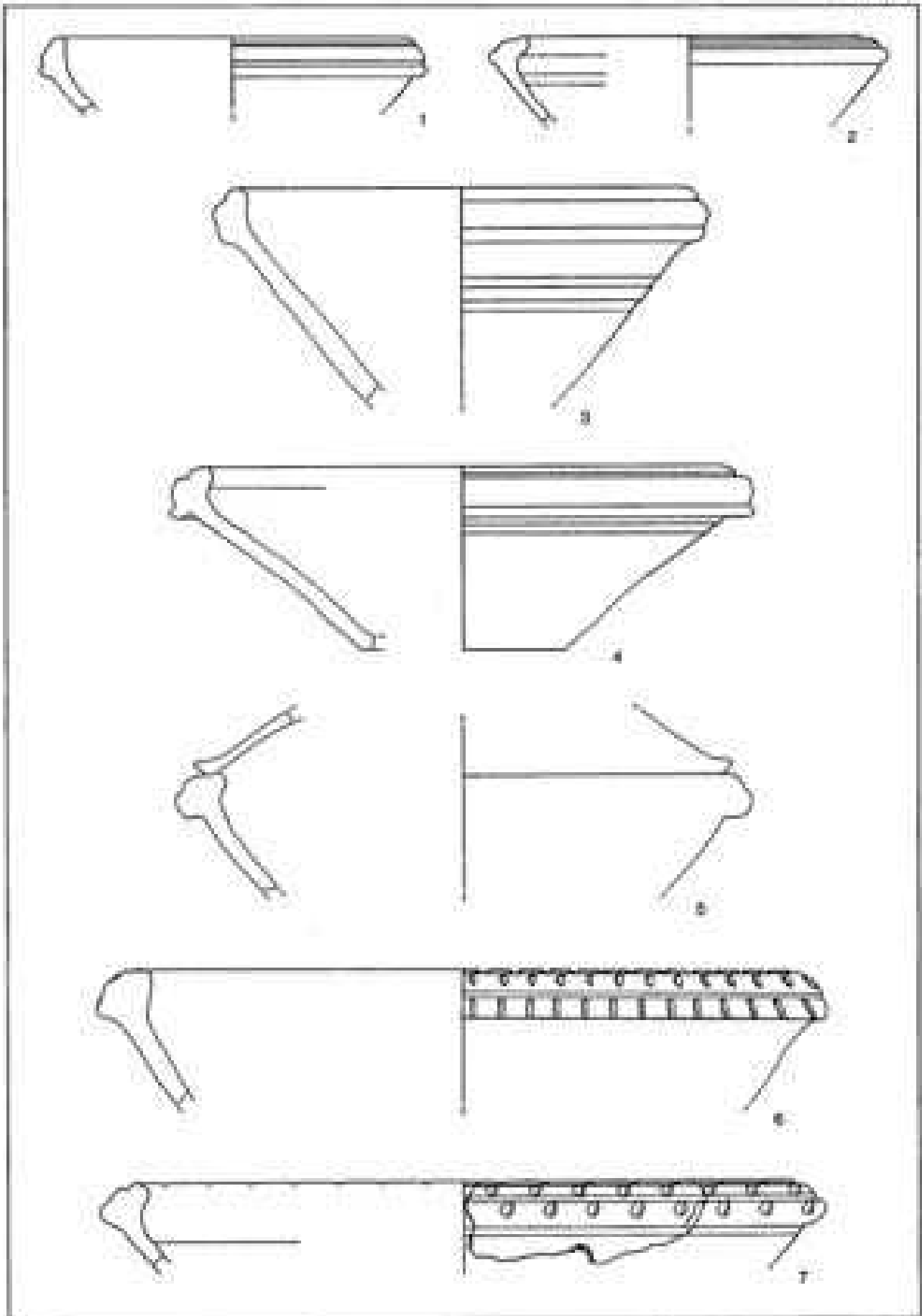

Schüssel (Typ 3). M. 1:3.

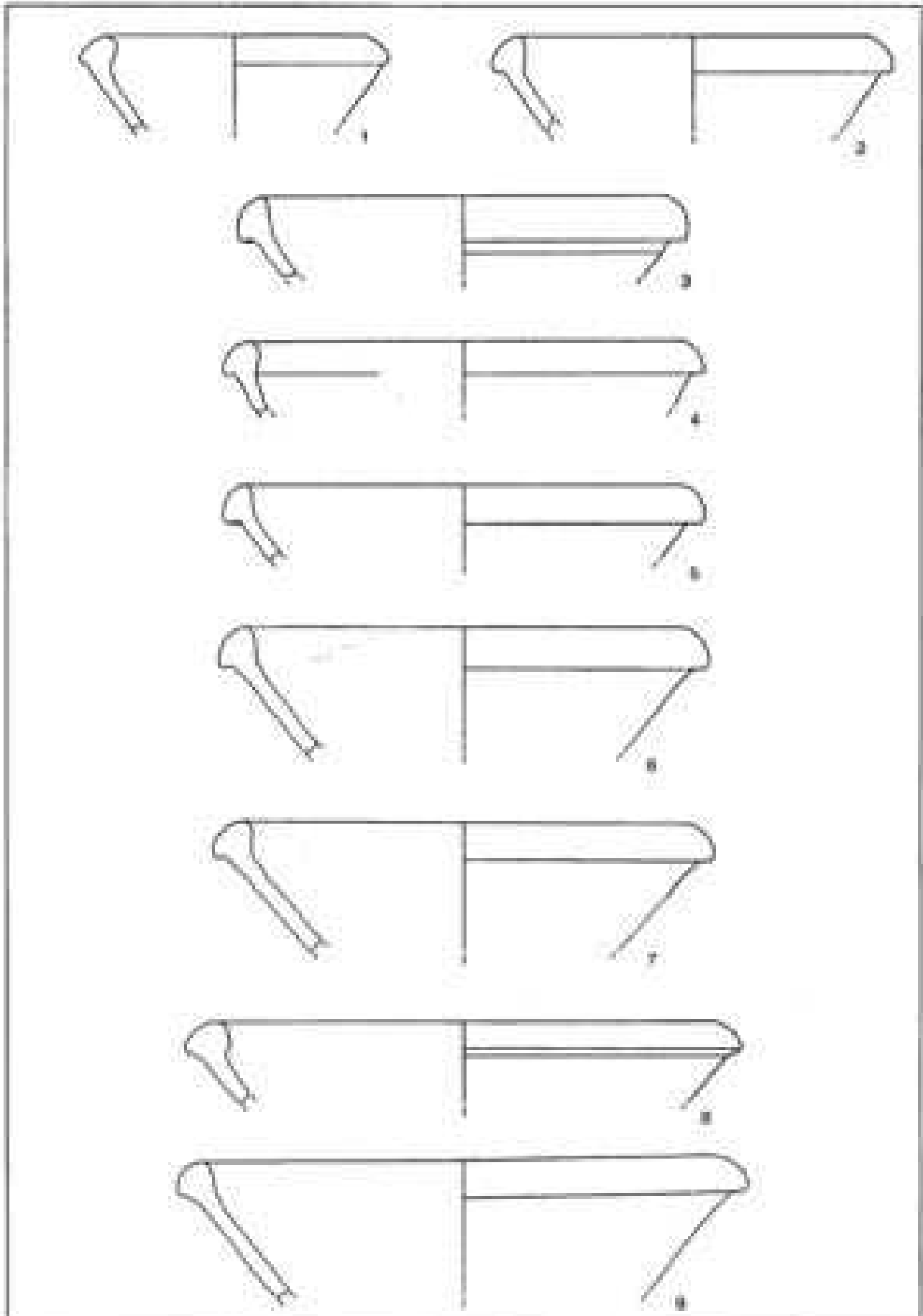

Schlüssel (Typ 4). M. 1:3

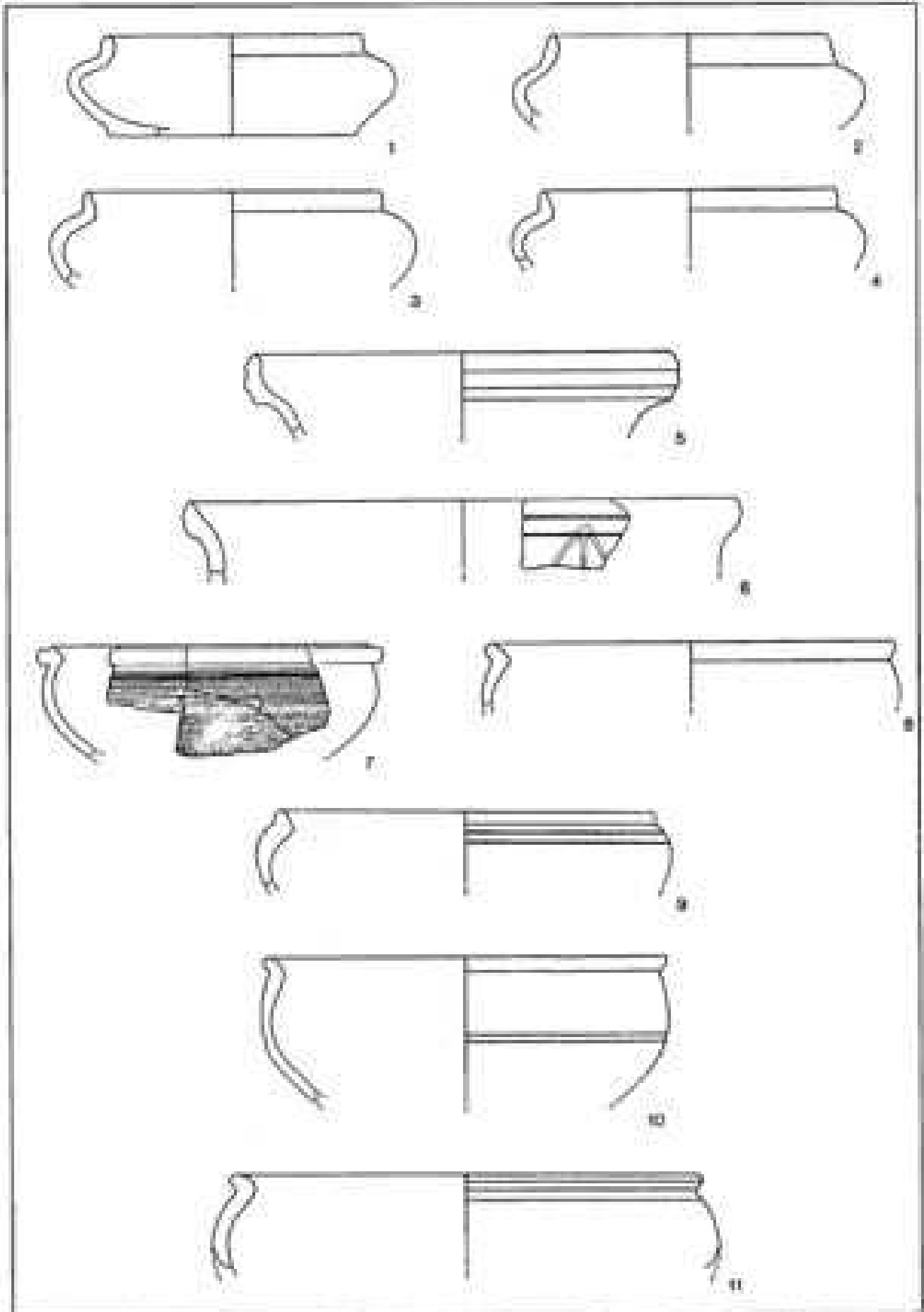

1-4 Schüssel (Typ B), 5-6 Schüssel (Typ B), 7-11 Schüssel (Bonder- und Einzelformen) . M. 1/3.

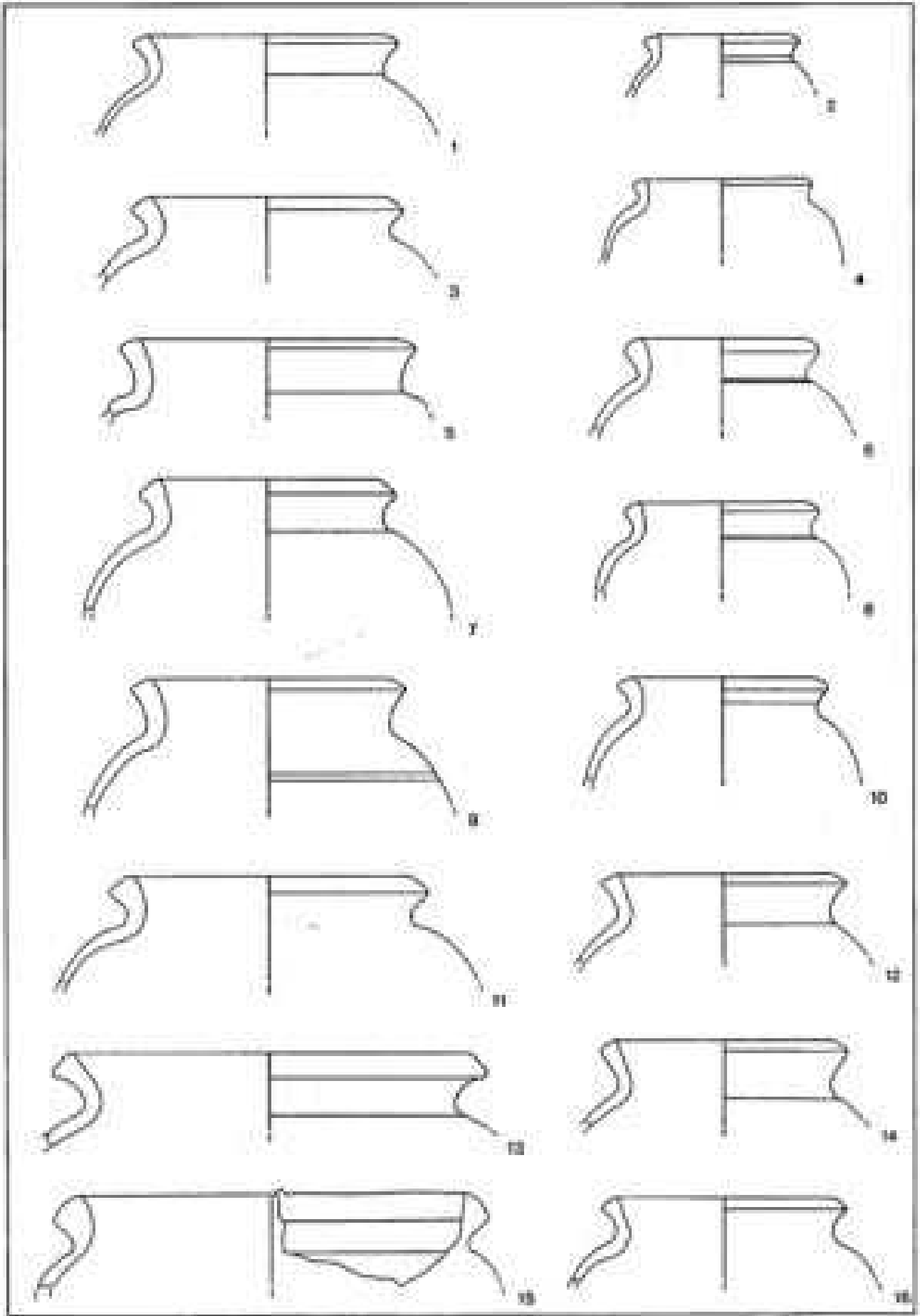

Topf (Typ 11, M. 1/3)

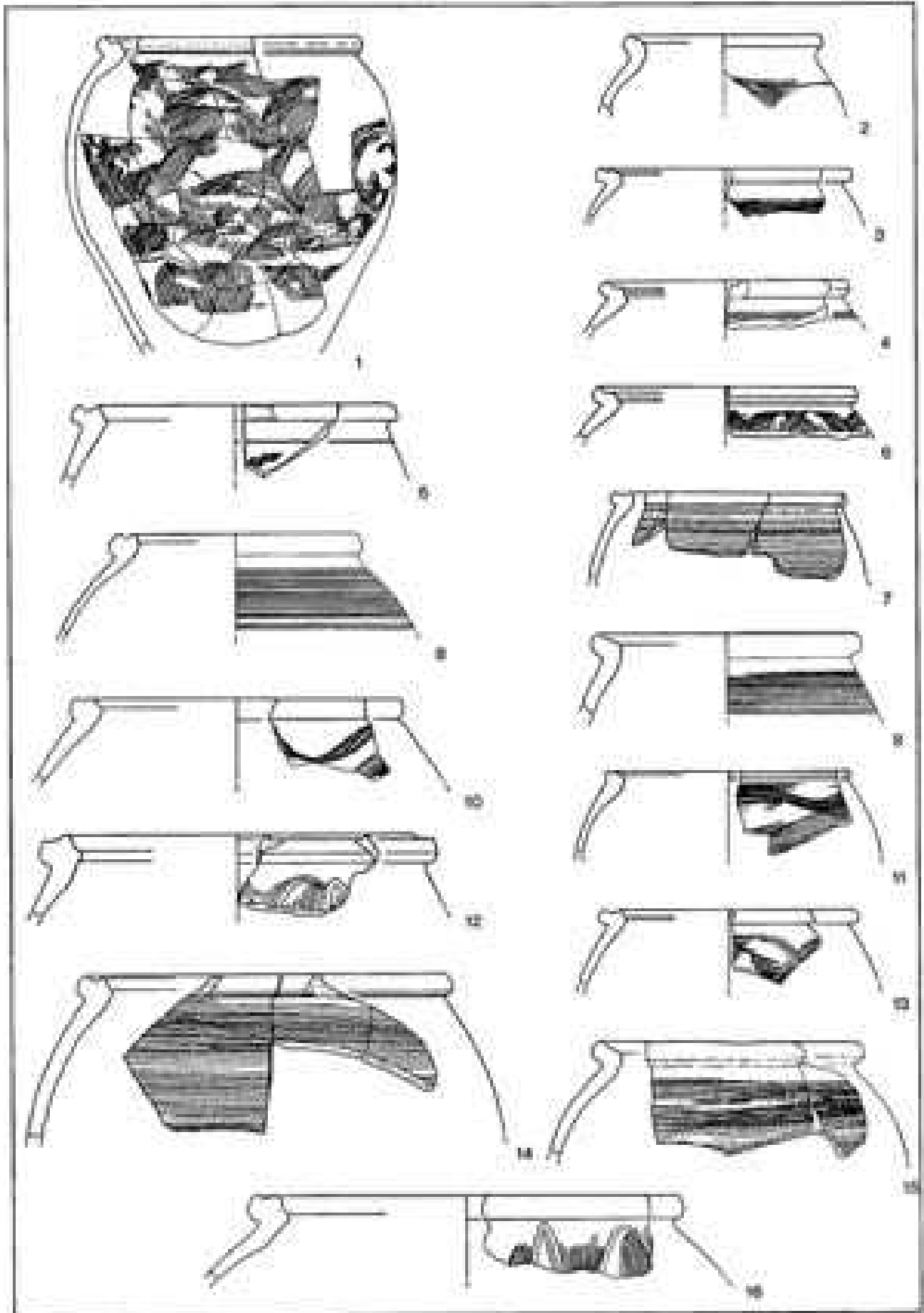

Topf (Typ 2), M. 1-3

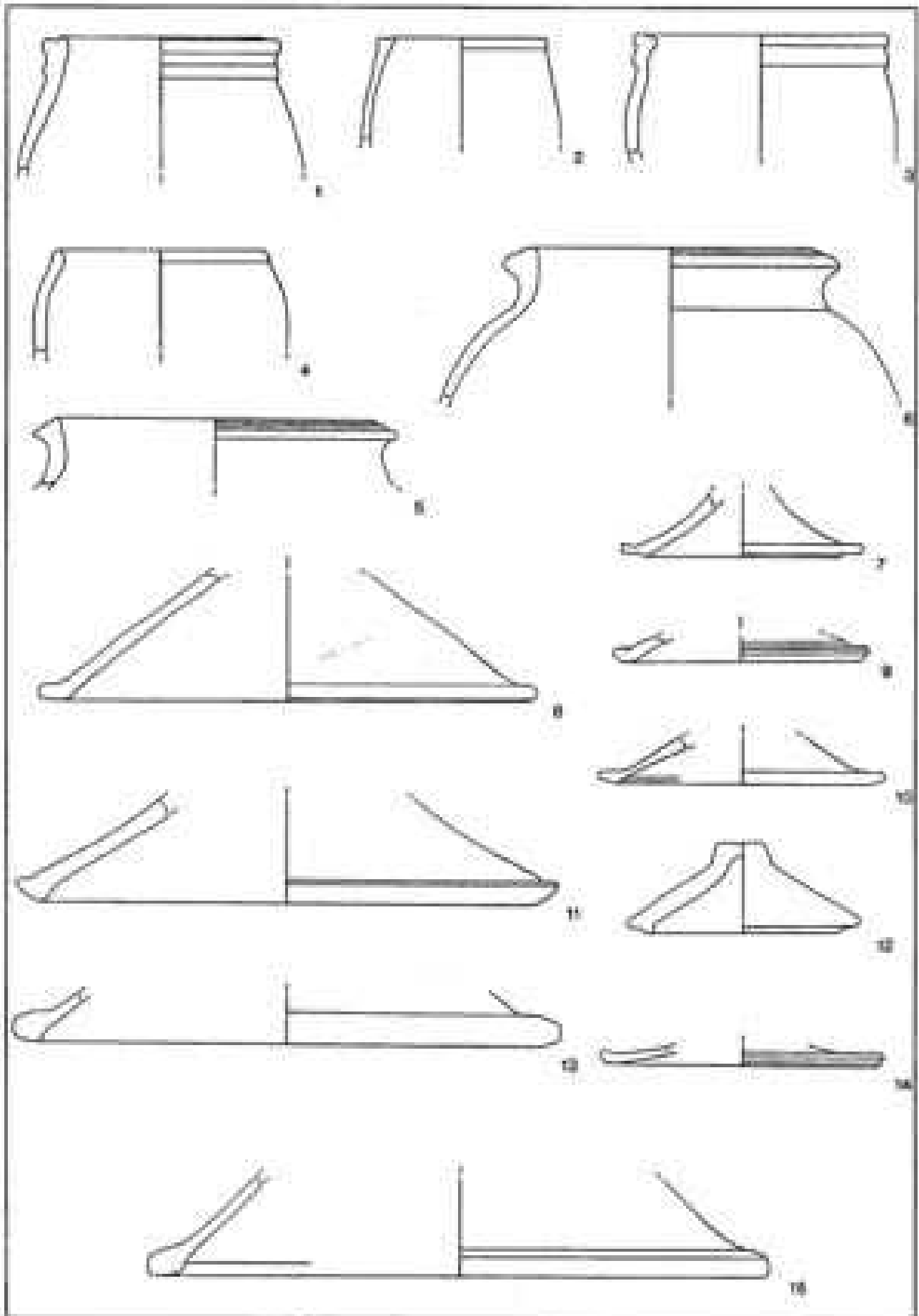

1-3 Toepf (Typ 3), 4 Toepf (Typ 4), 5-6 Toepf (Typ 5), 7-19 Deckel. M. 1:3.

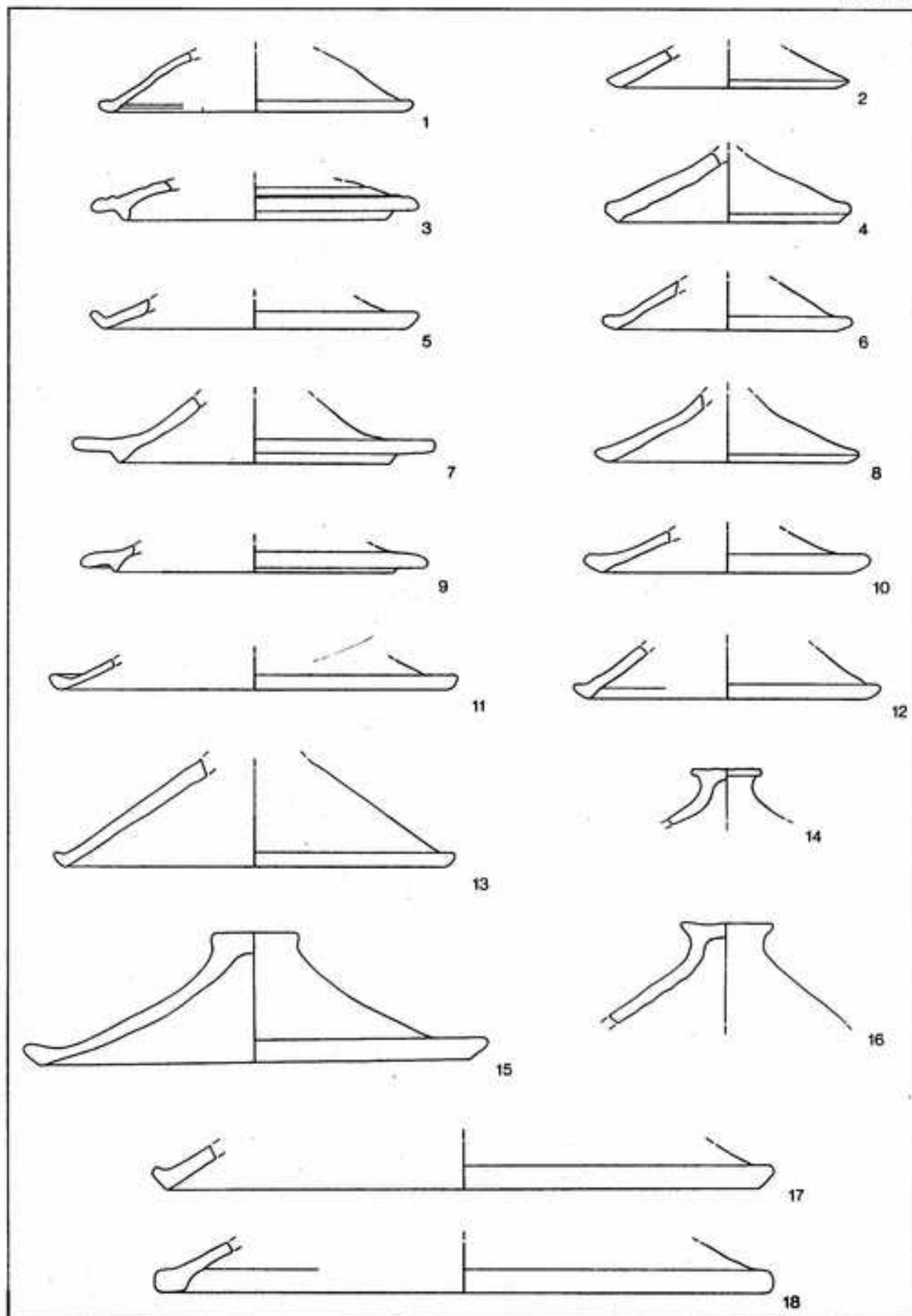

Deckel. M. 1:3.

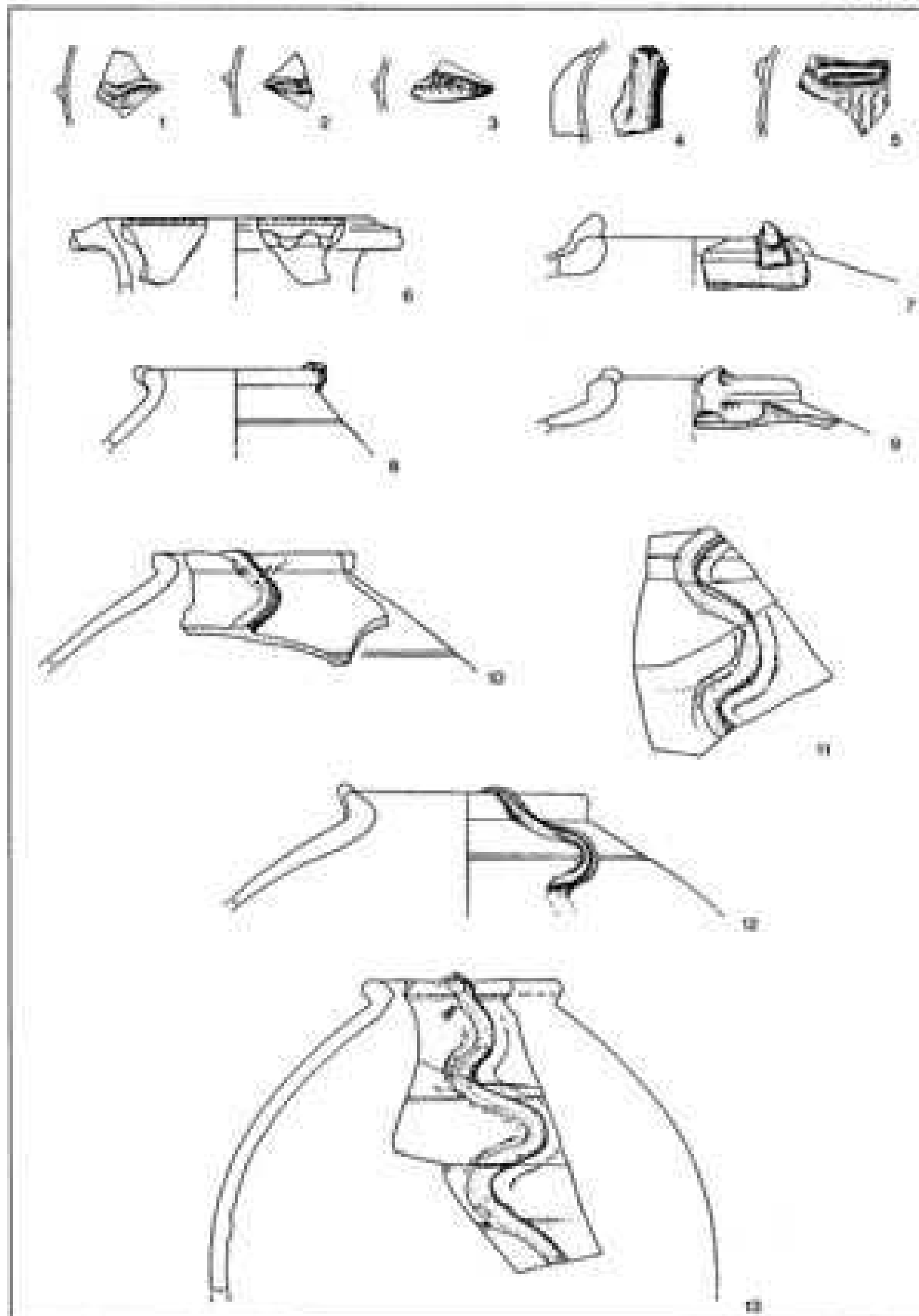

1-5 Gesichtsmasken, 6 Räucherkelch, 7-13 Schlangenvasen.
M. 1:3.

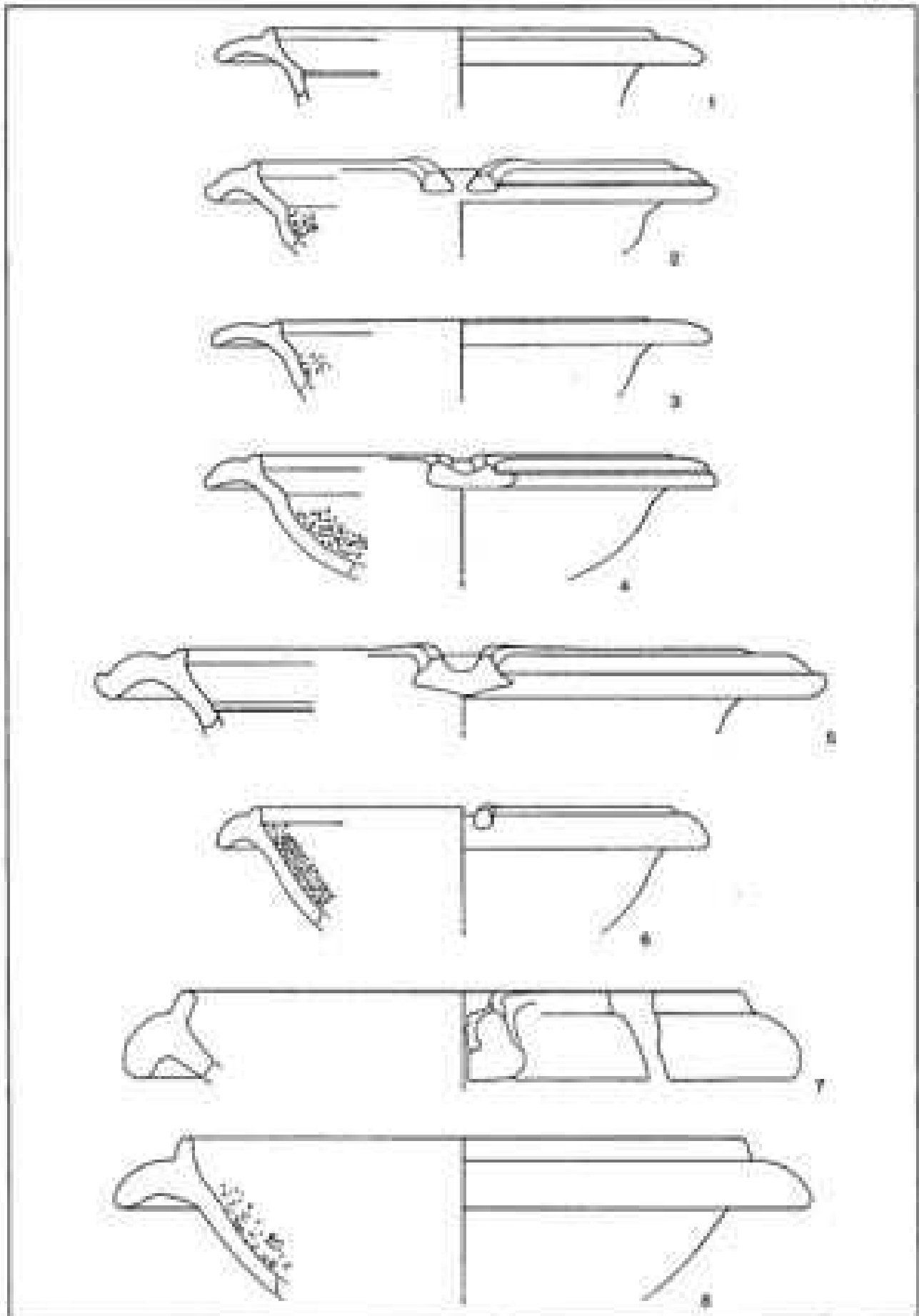

1-5 Reibschüssel (Typ 1), 6-7 Reibschüssel (Typ 2), 8 M. 1:3.

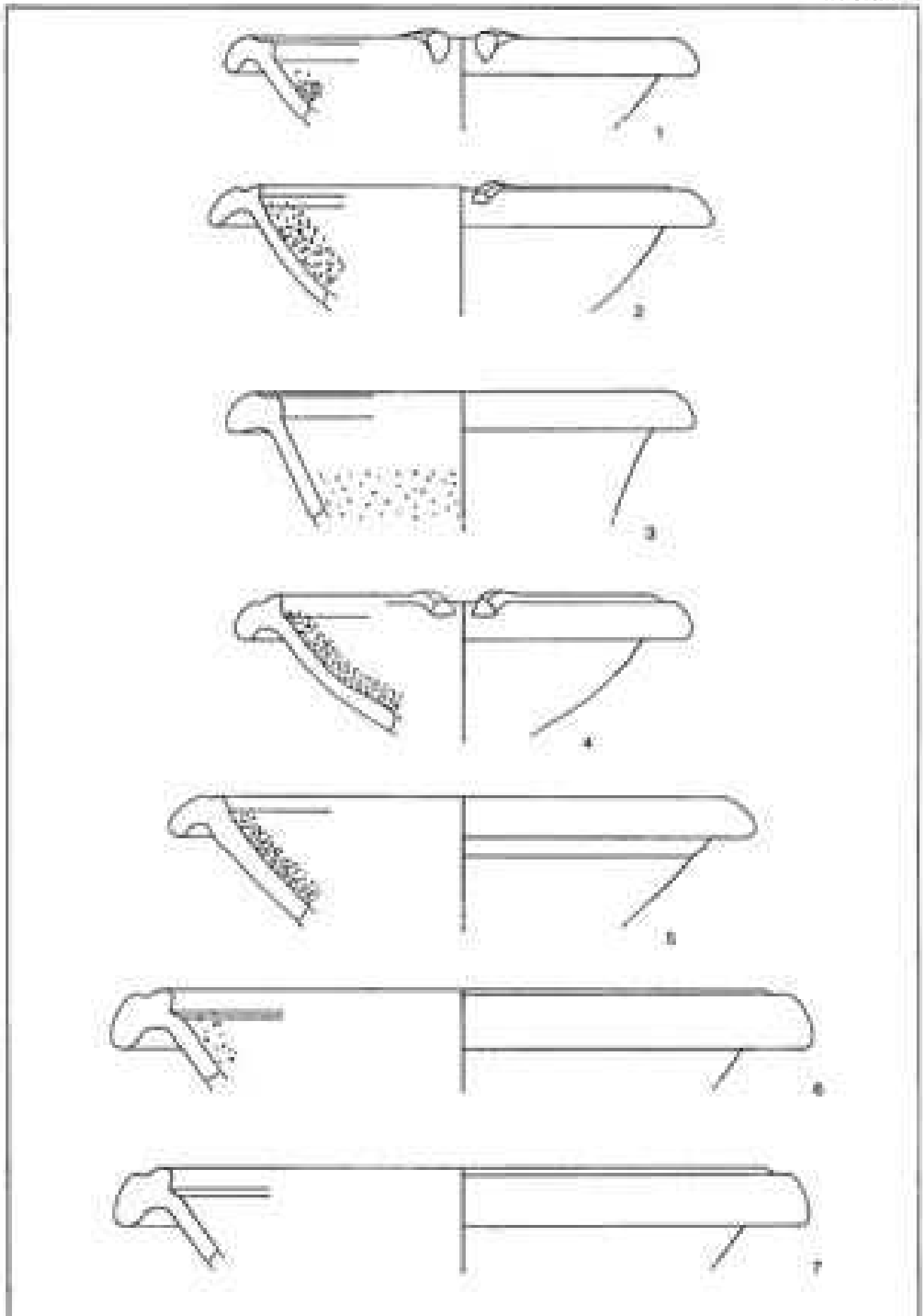

1-2 Rebschüssel (Typ 2), 3-7 Rebschüssel (Typ 3), M. 1/3.

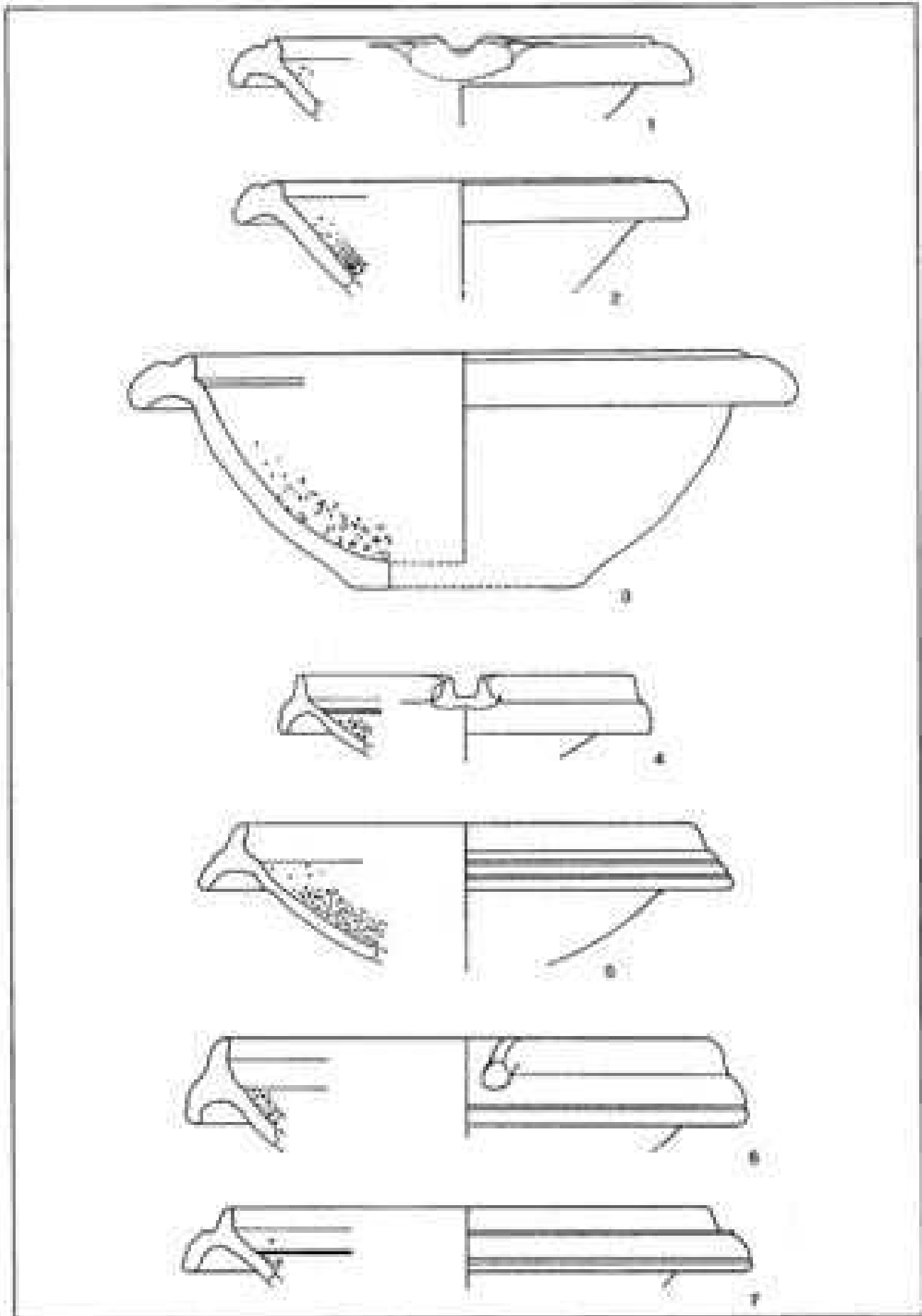

1-3 Reibschüssel (Typ 36), 4-7 Reibschüssel (Typ 46), M. 1:3.

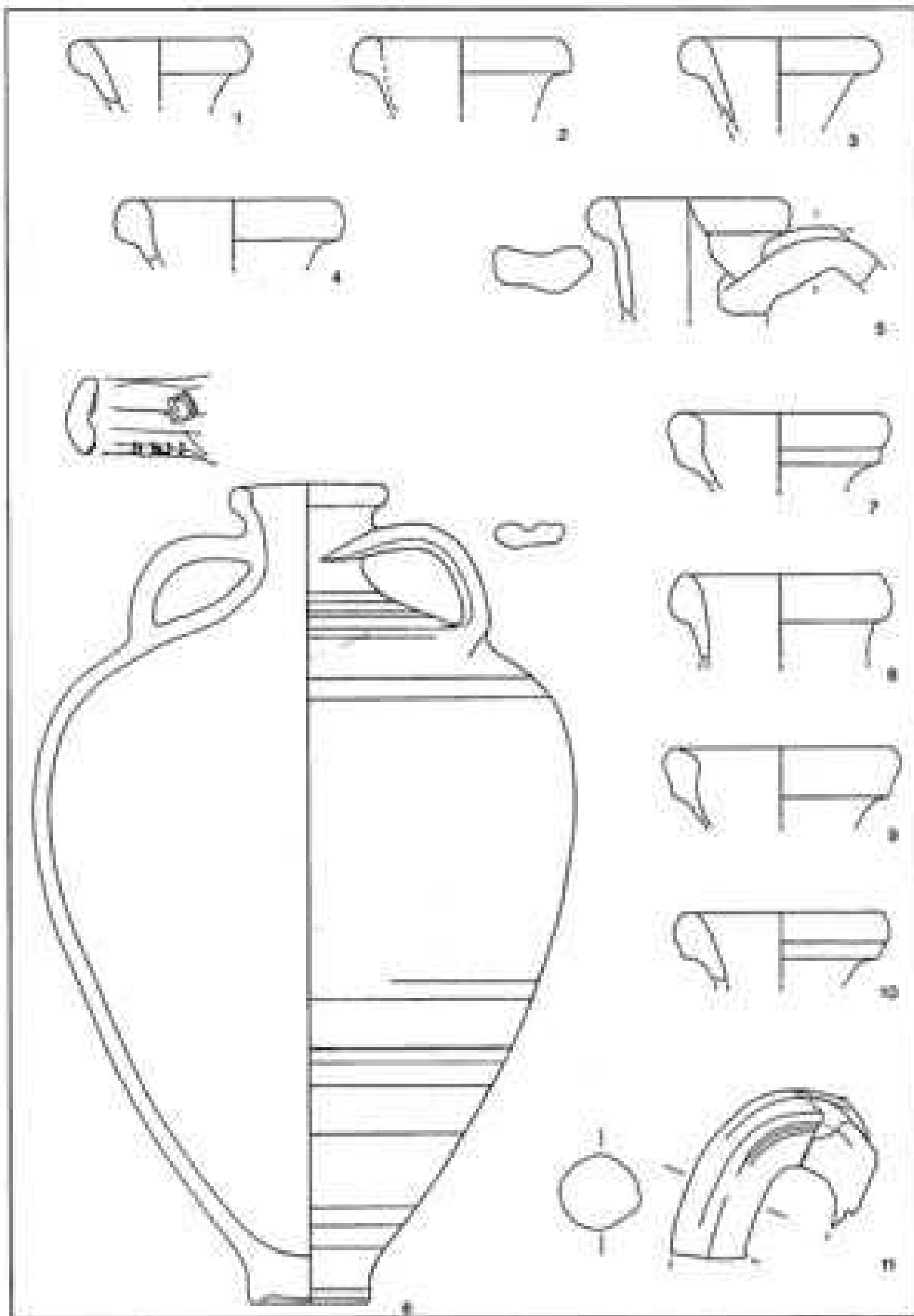

Amphore (Typ Gauloise 4). 1-5.9-11 M. 1:3. 6 M. 1:4.

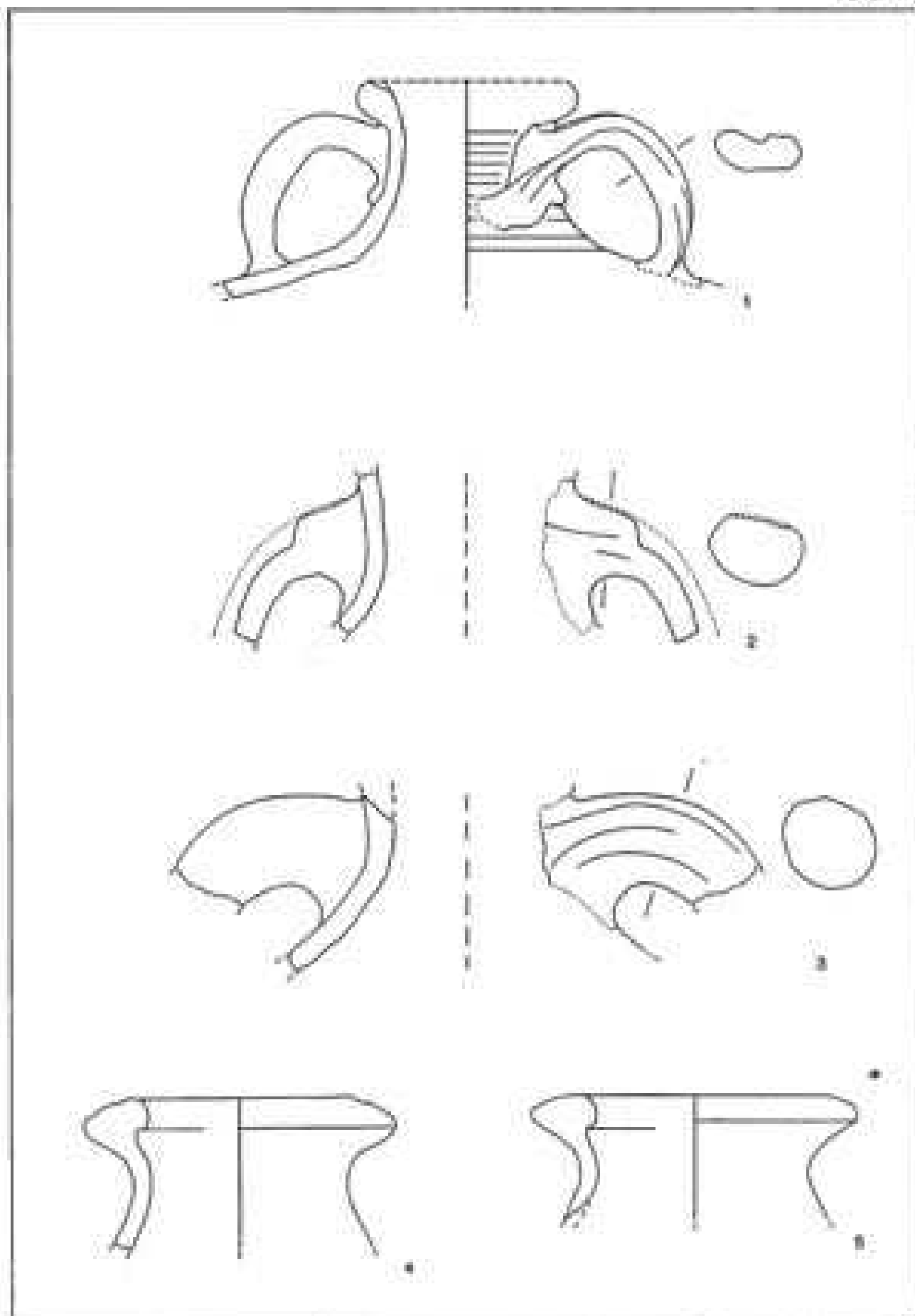

1-3 Amphore (Typ Gauloise 4), 4-5 Amphore (Typ Dressel 20).
M. 1:3.

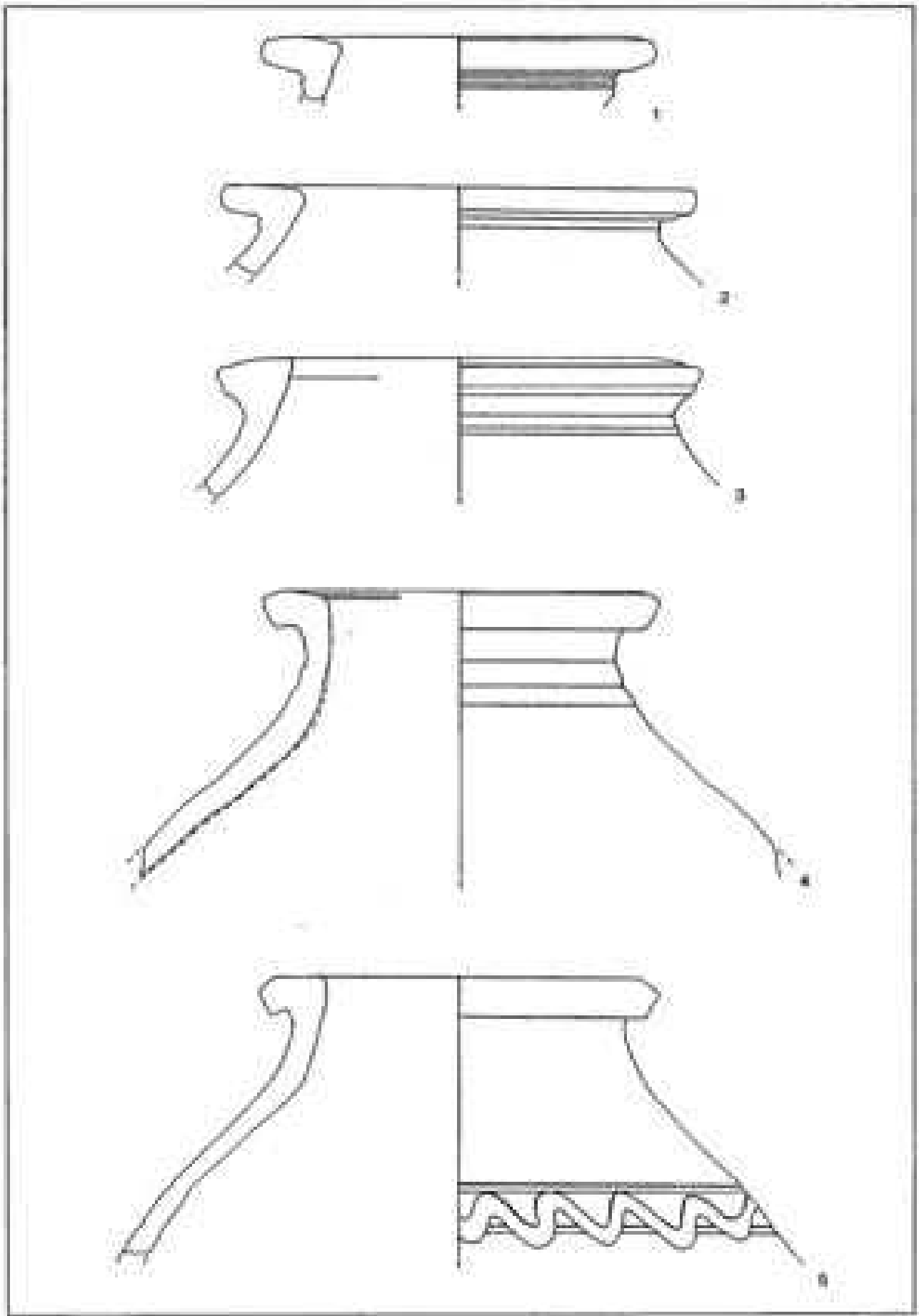

Dorfen. M. 1:3.

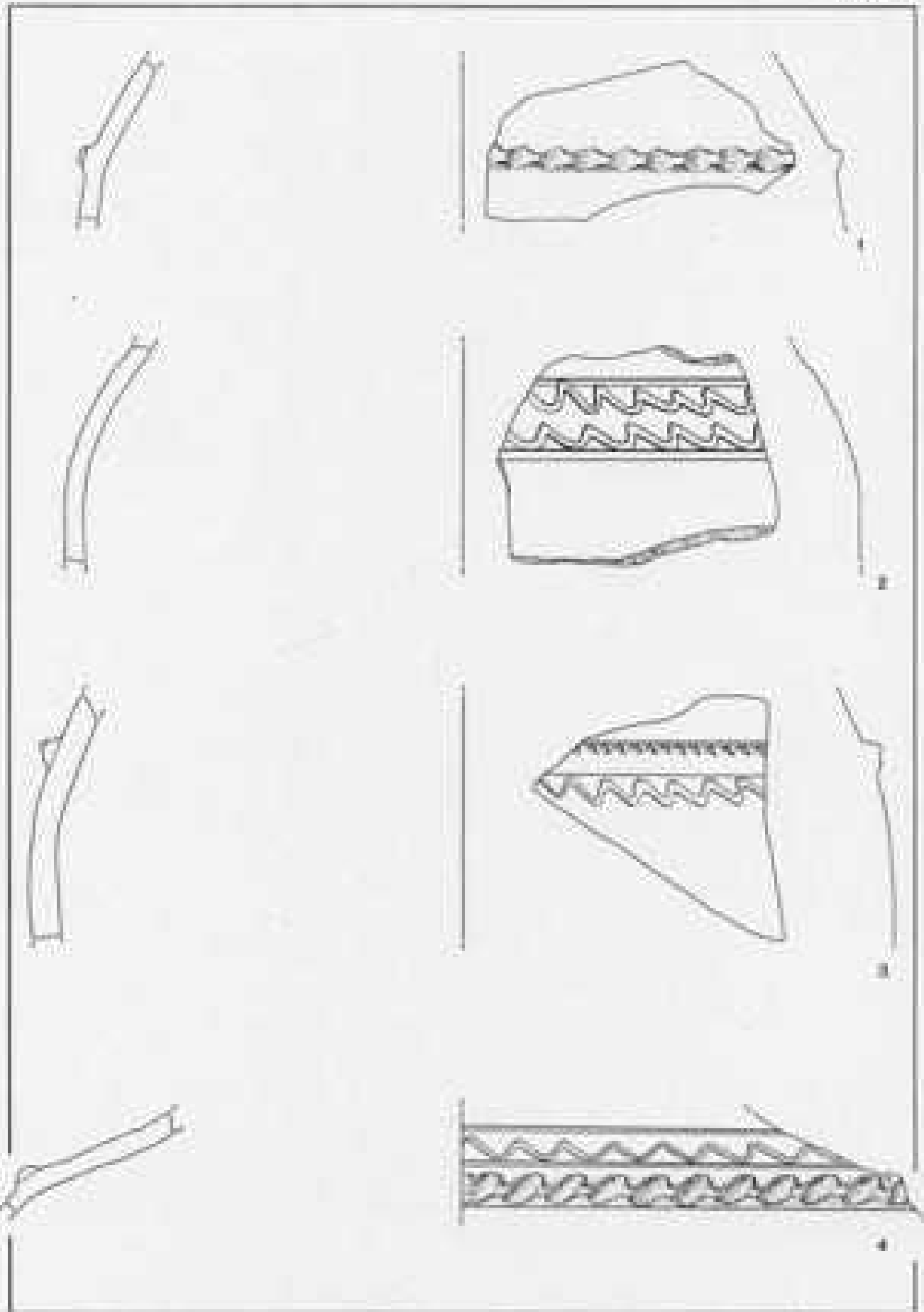

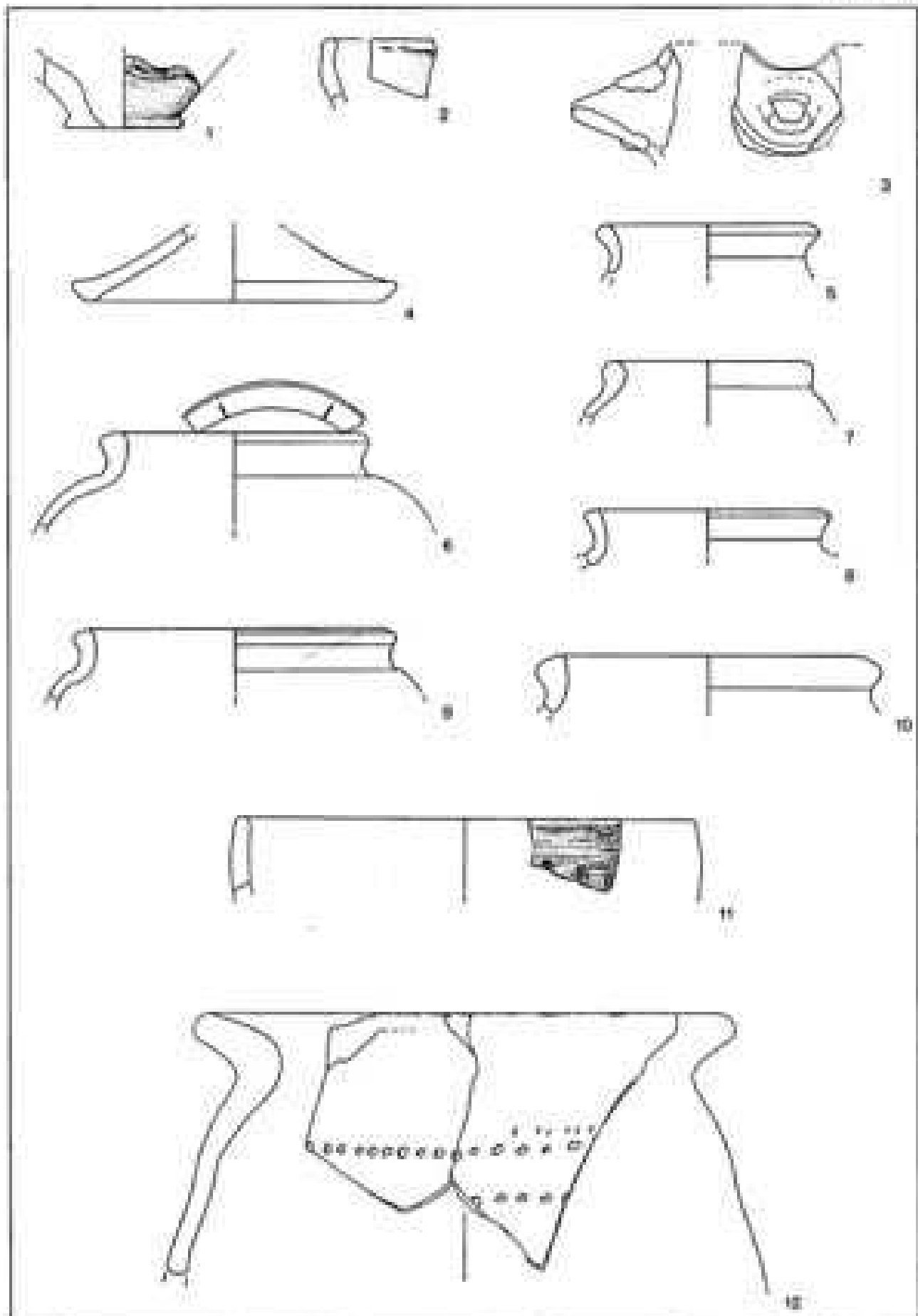

Freigeformte (Handgemachte) Ware. M. 1-3.

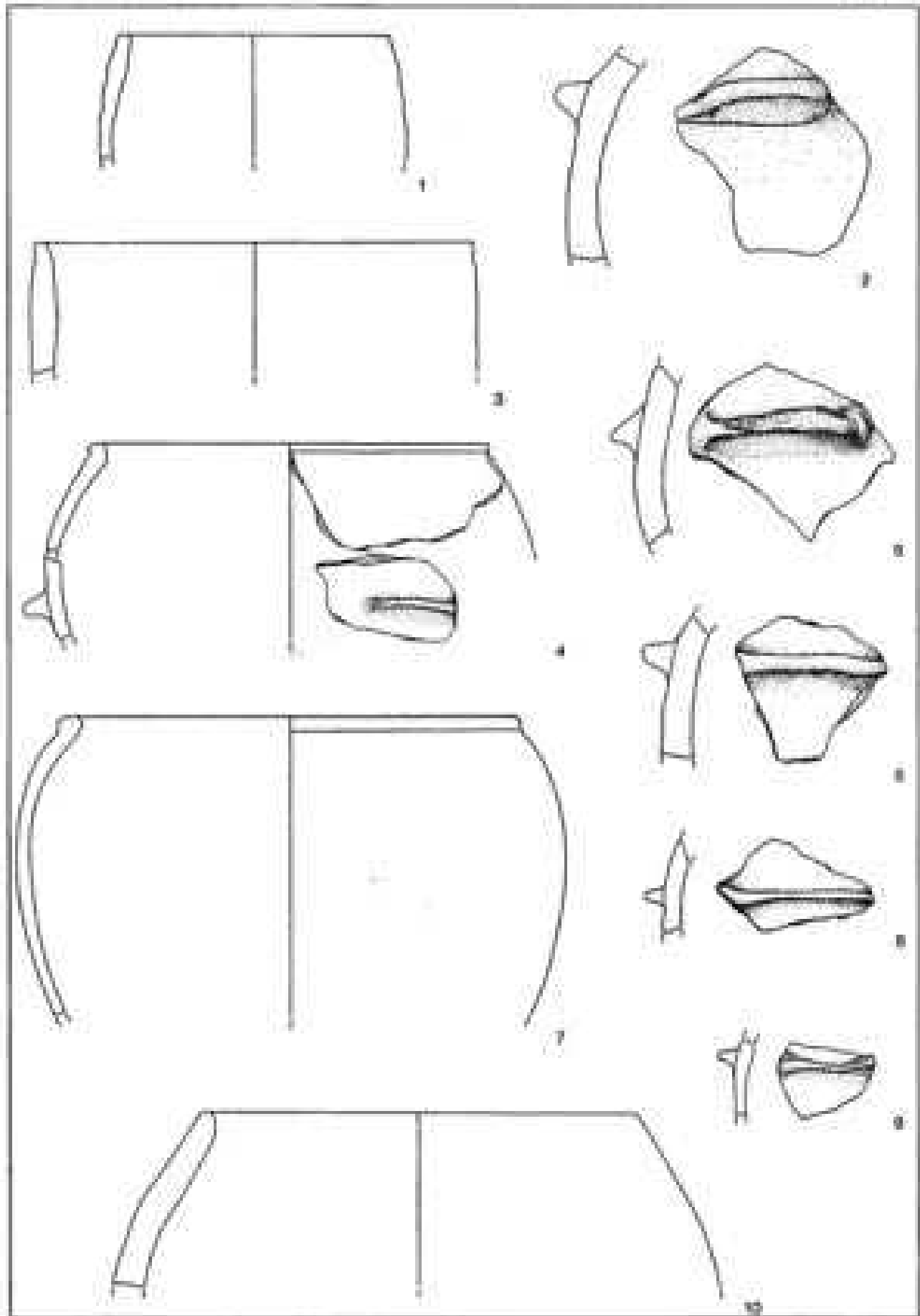

Freigeformte Handgemachte Ware. M. 1:3.

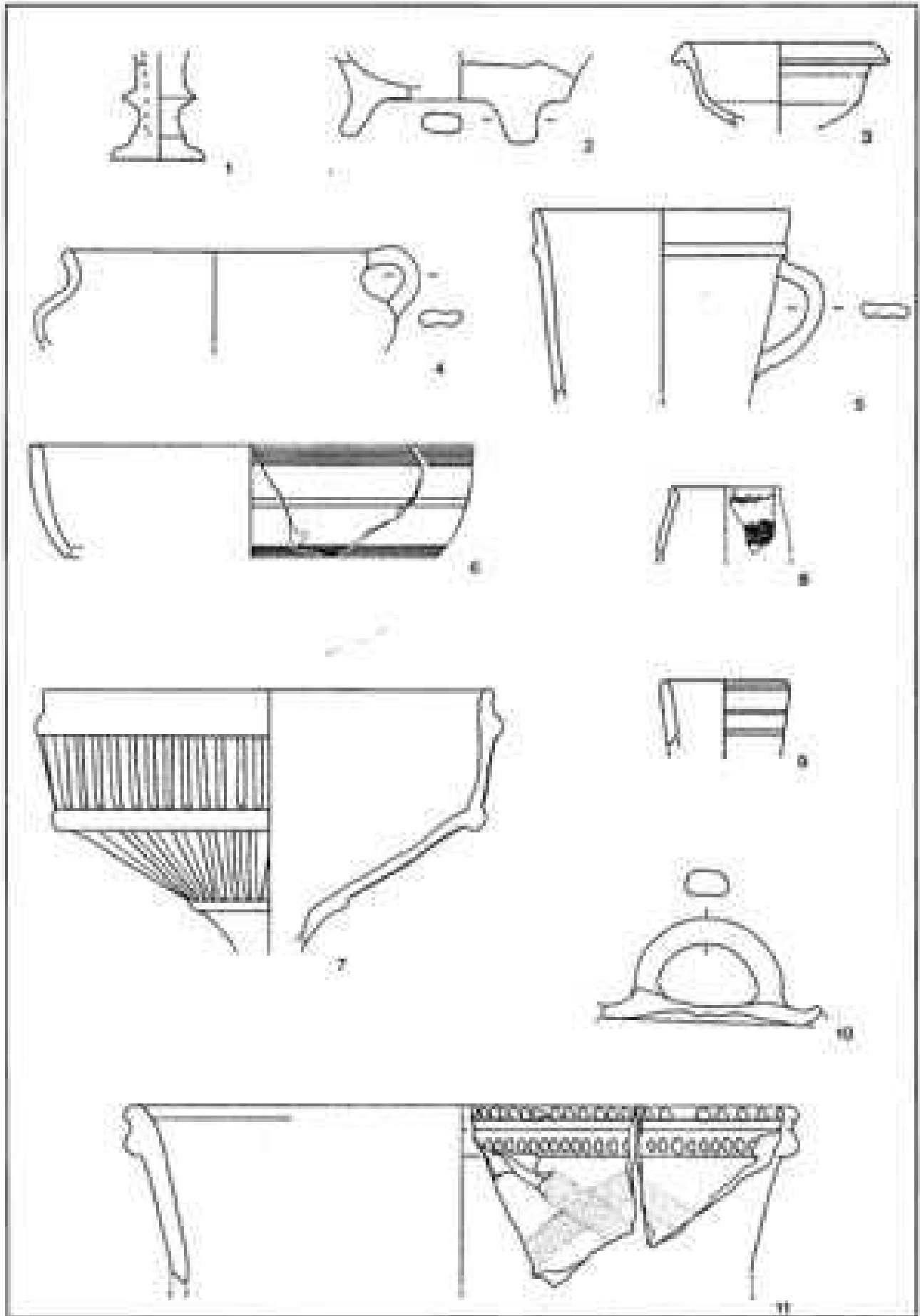

1-5, 7-11 Keramische Sonderformen, 6 Lavez. M. 1:3.

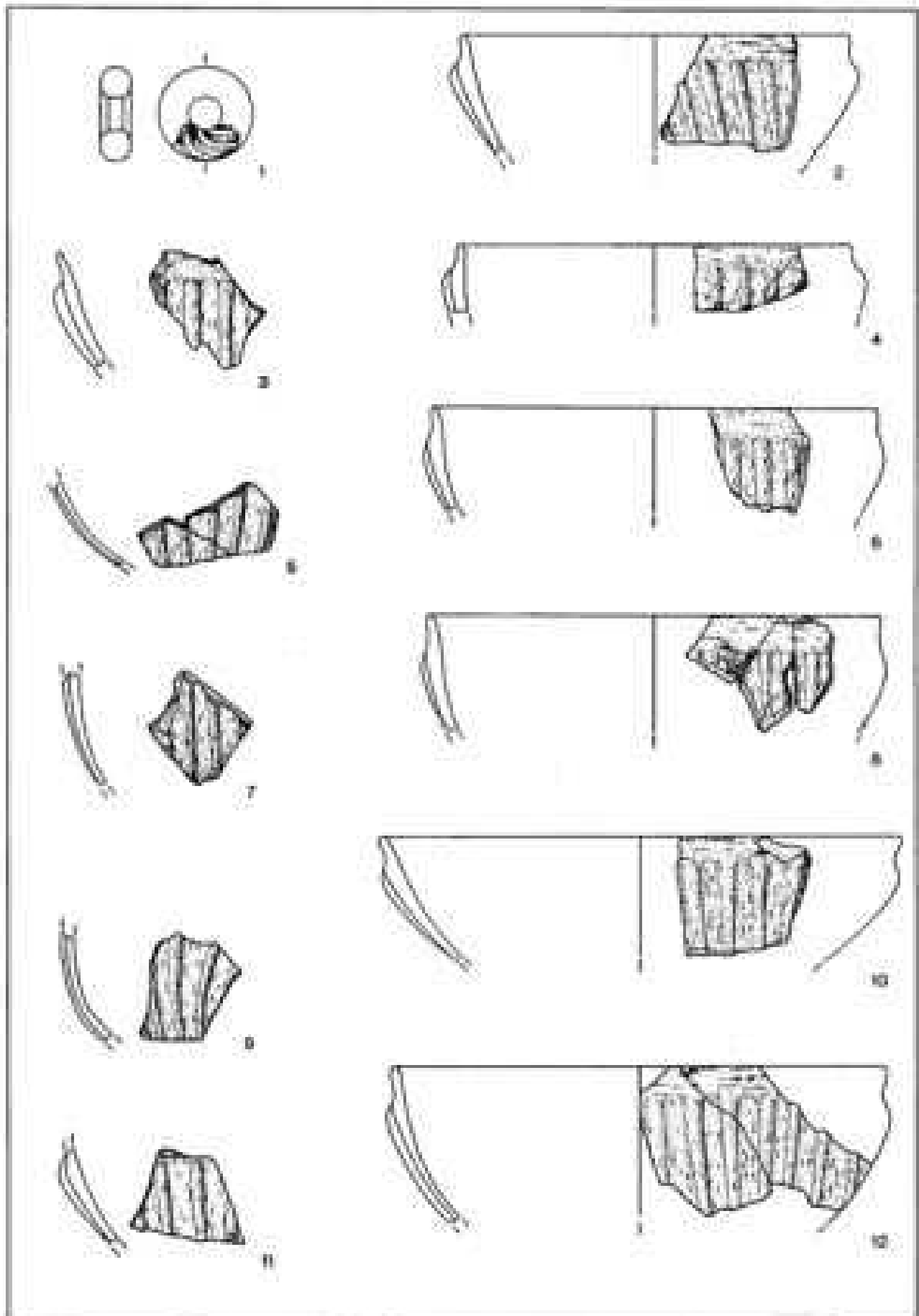

Glas. M. 1:2.

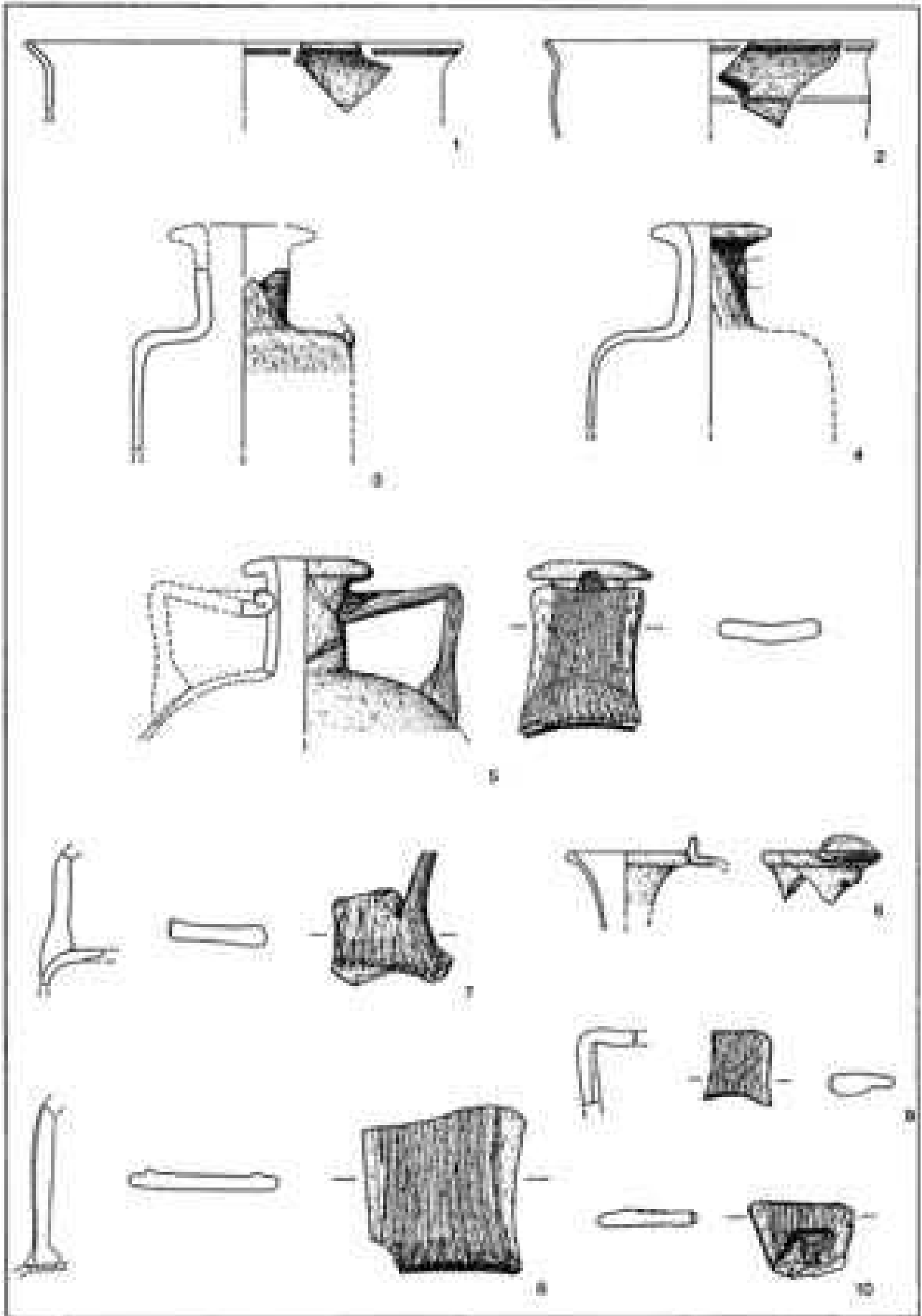

Glas. M. 1-2.

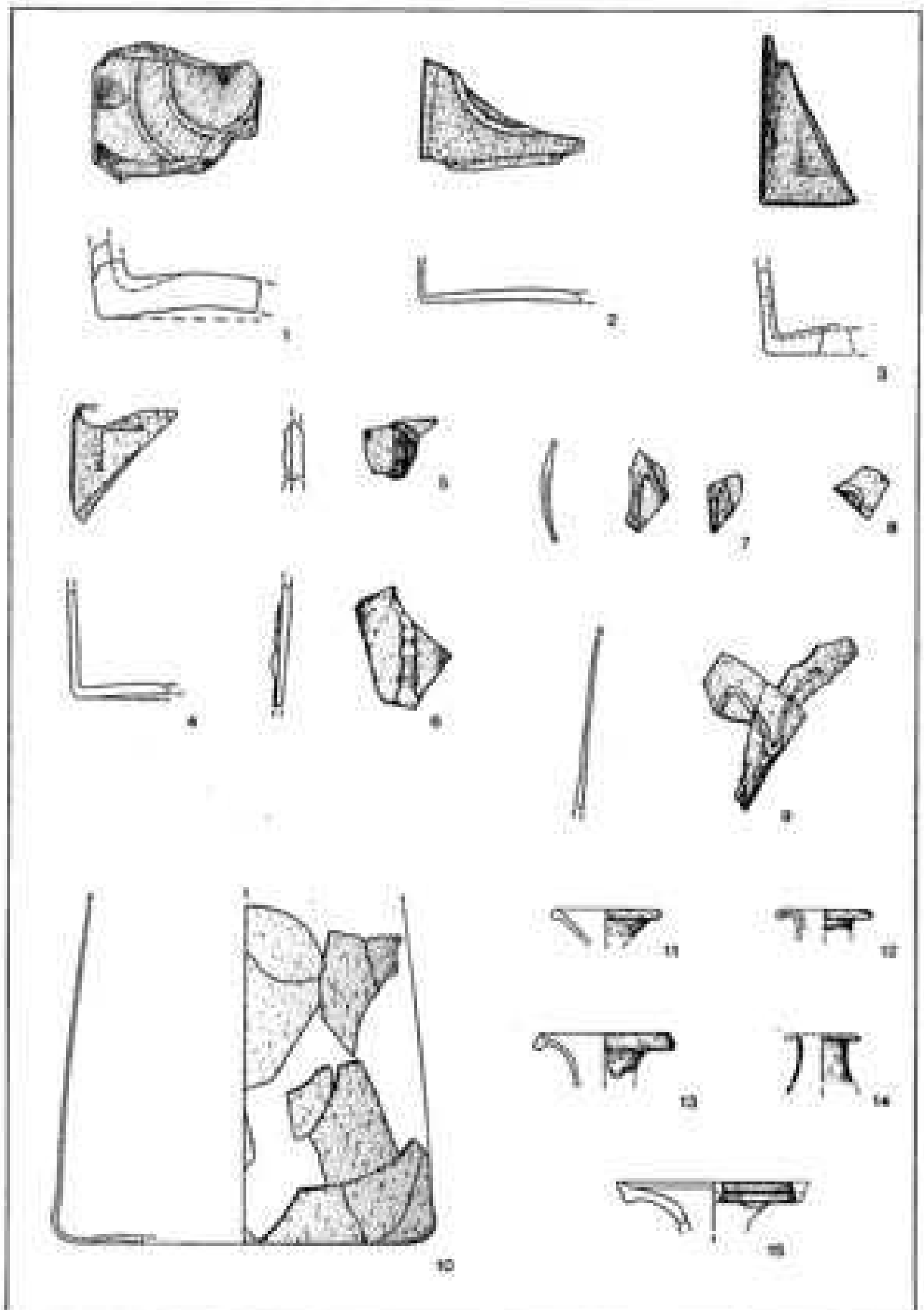

Clas. M. 1-2.

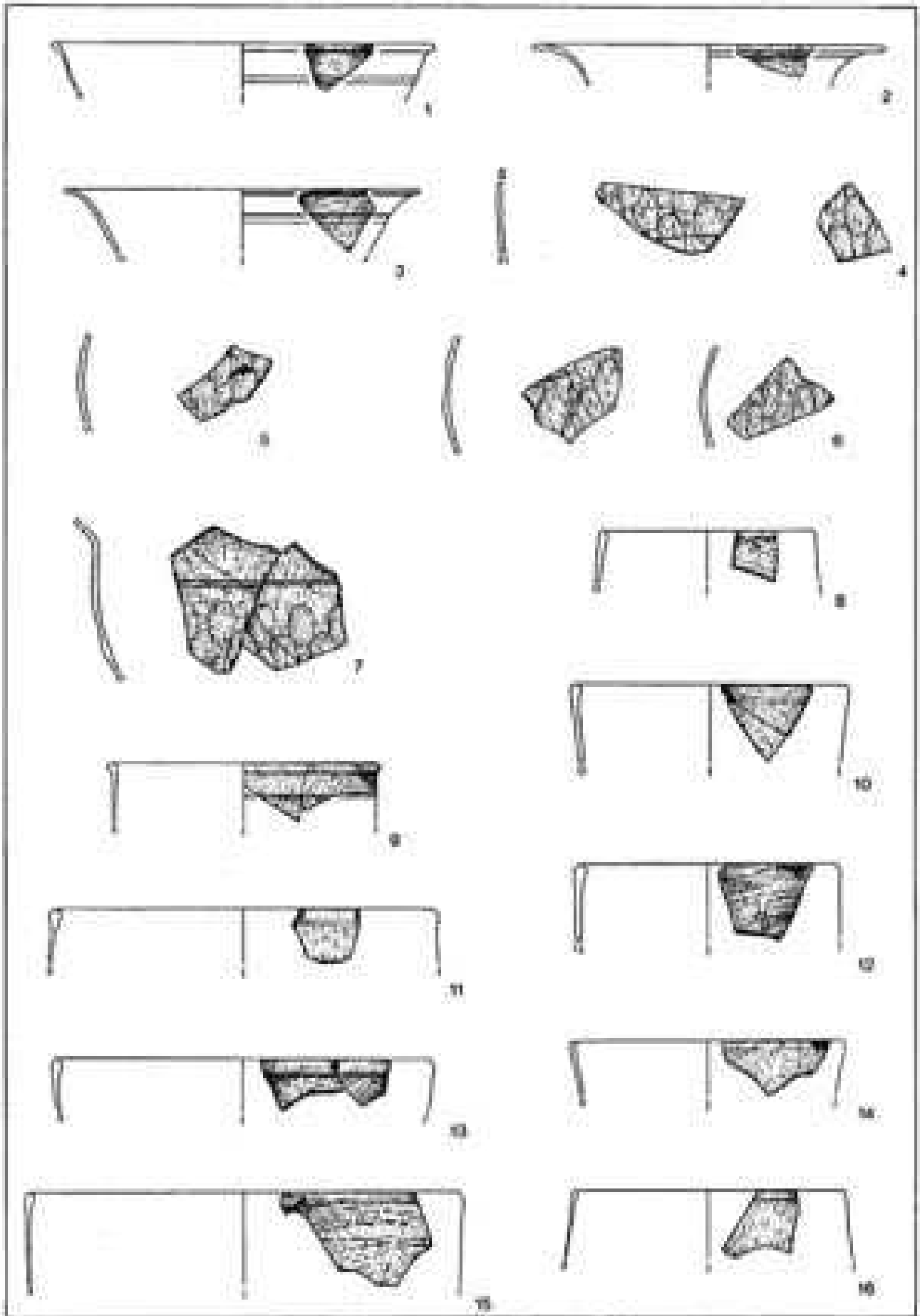

Ges. M. 1:2.

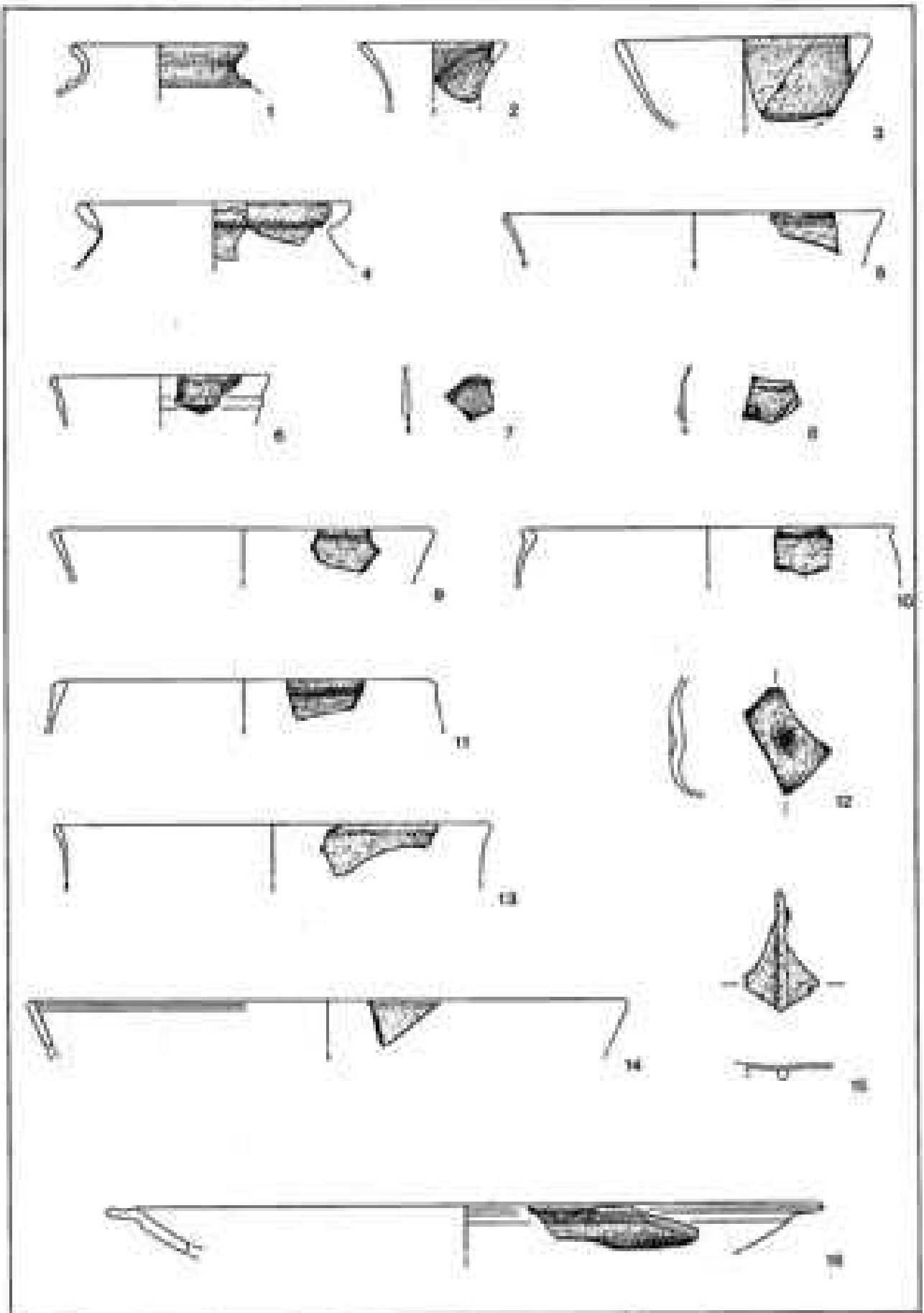

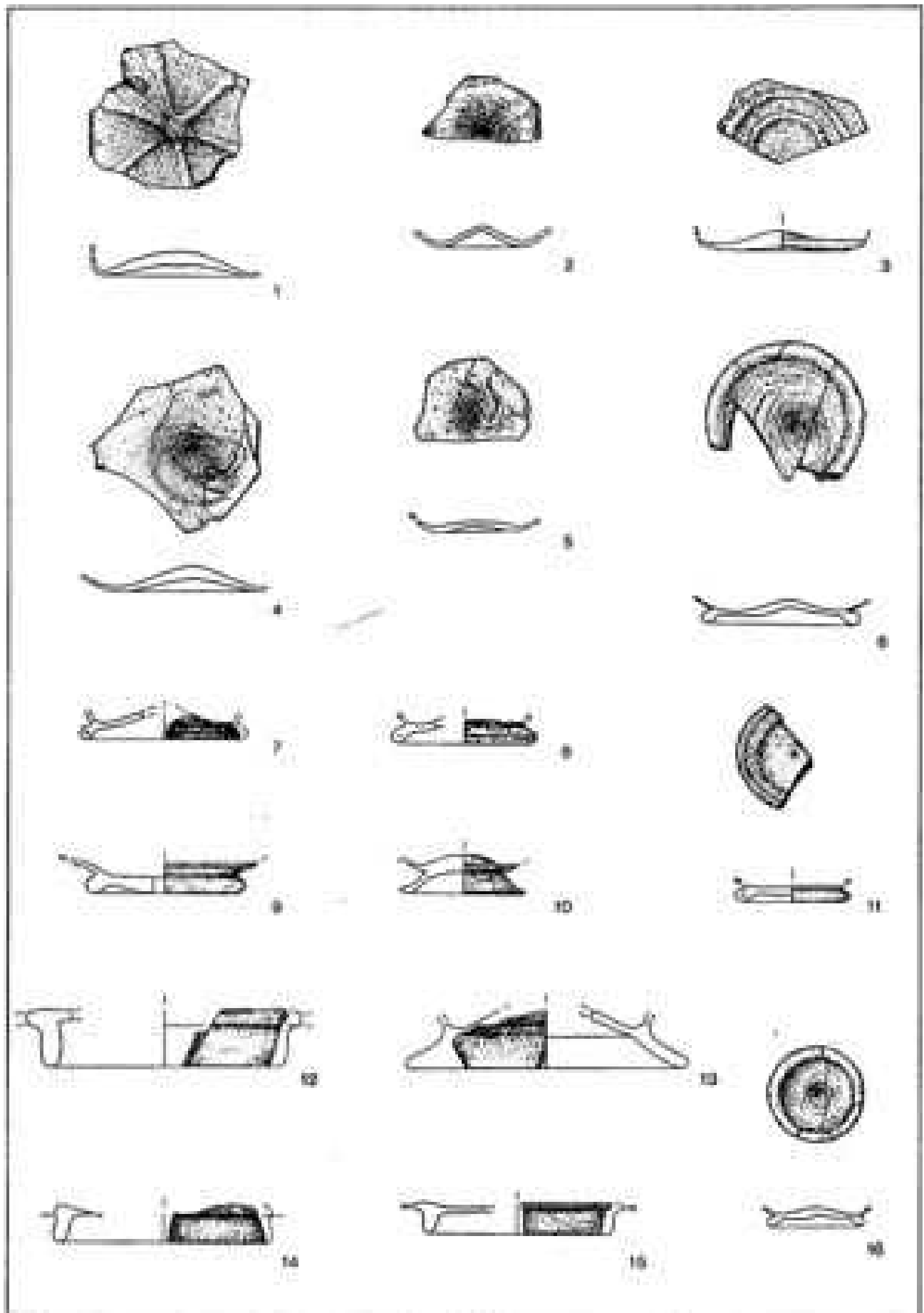

Glas. M. 1-2.

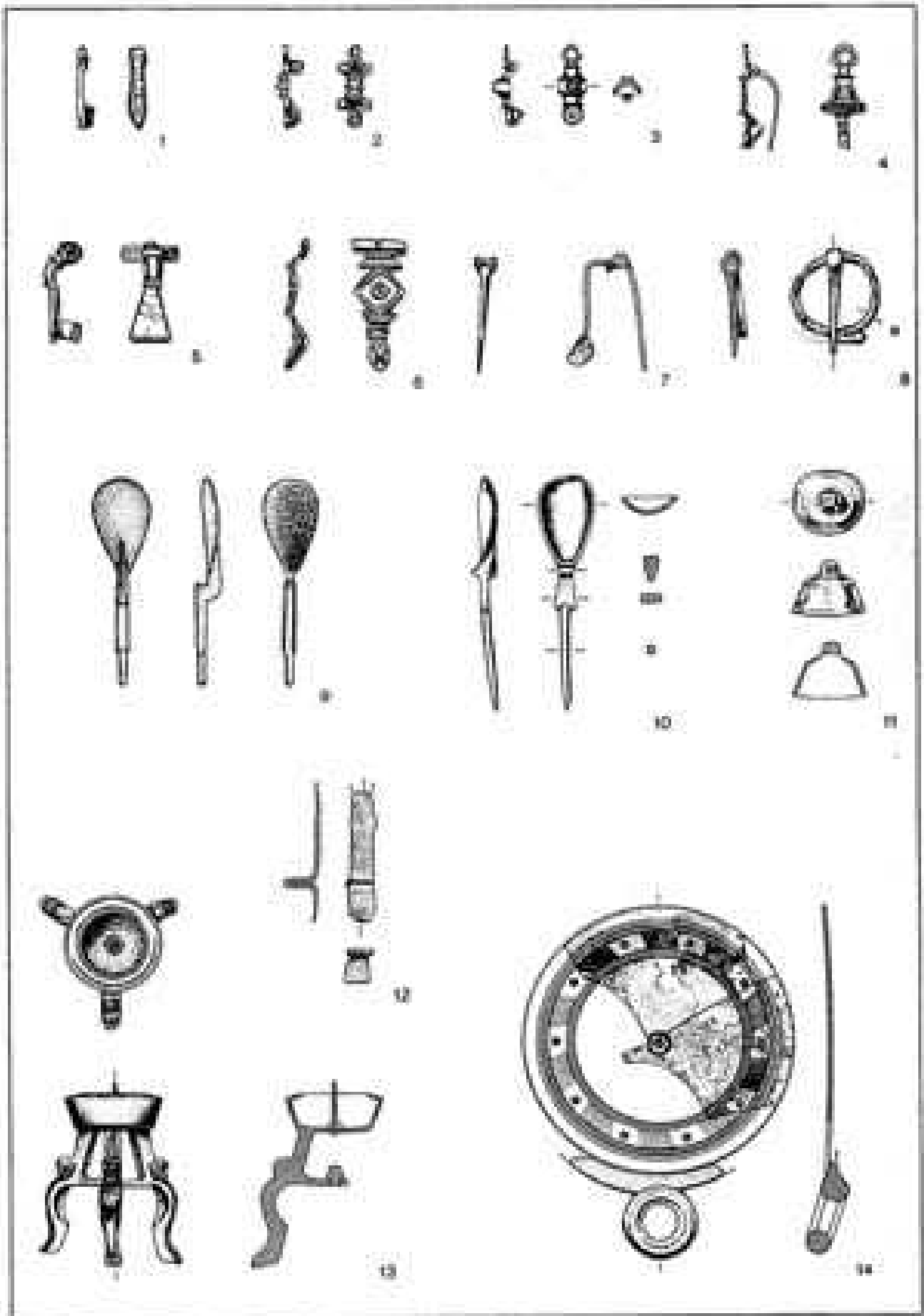

Bronze, M. 1:2.

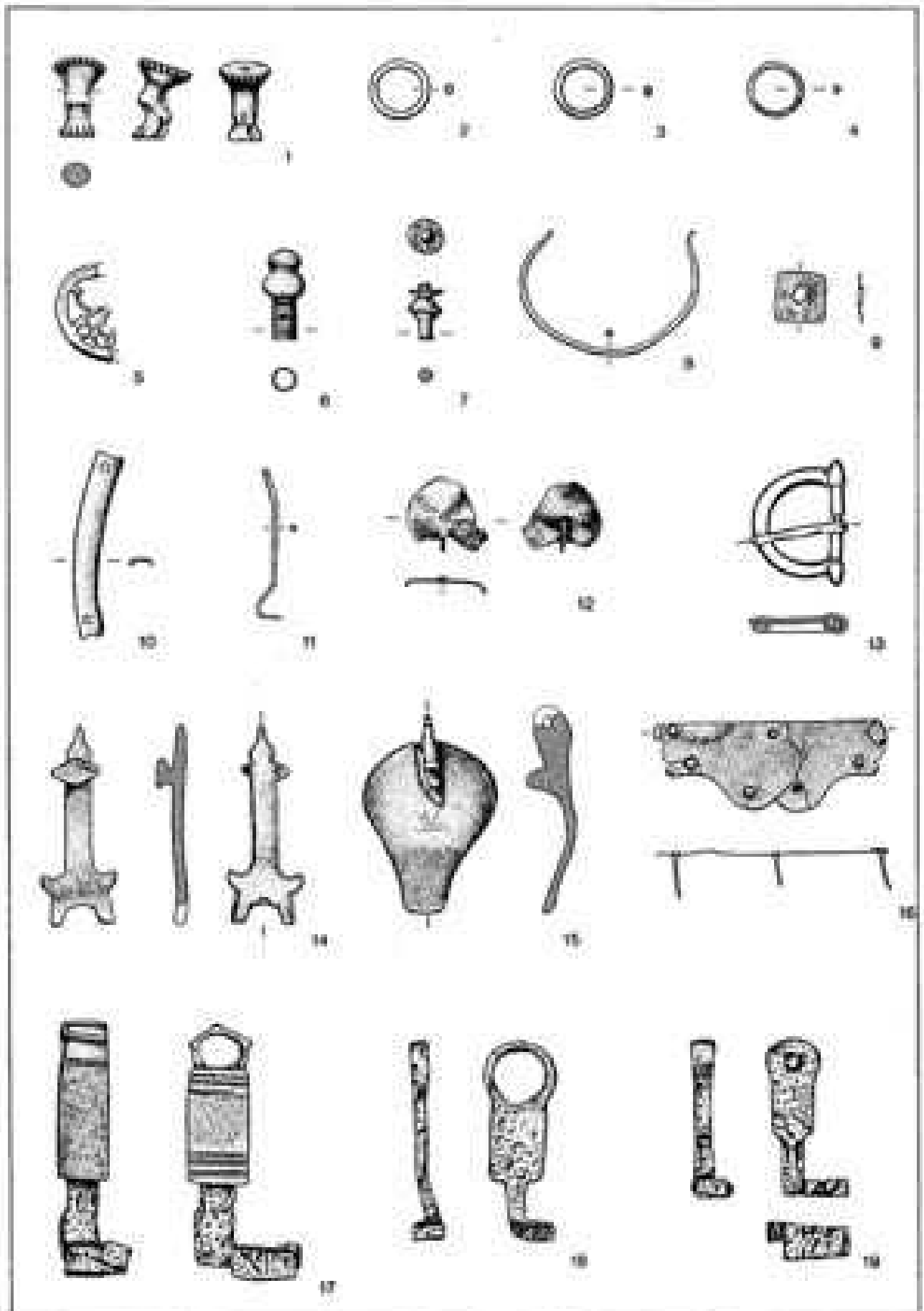

1-16 Bronze, 17-19 Eisen. M. 1:2.

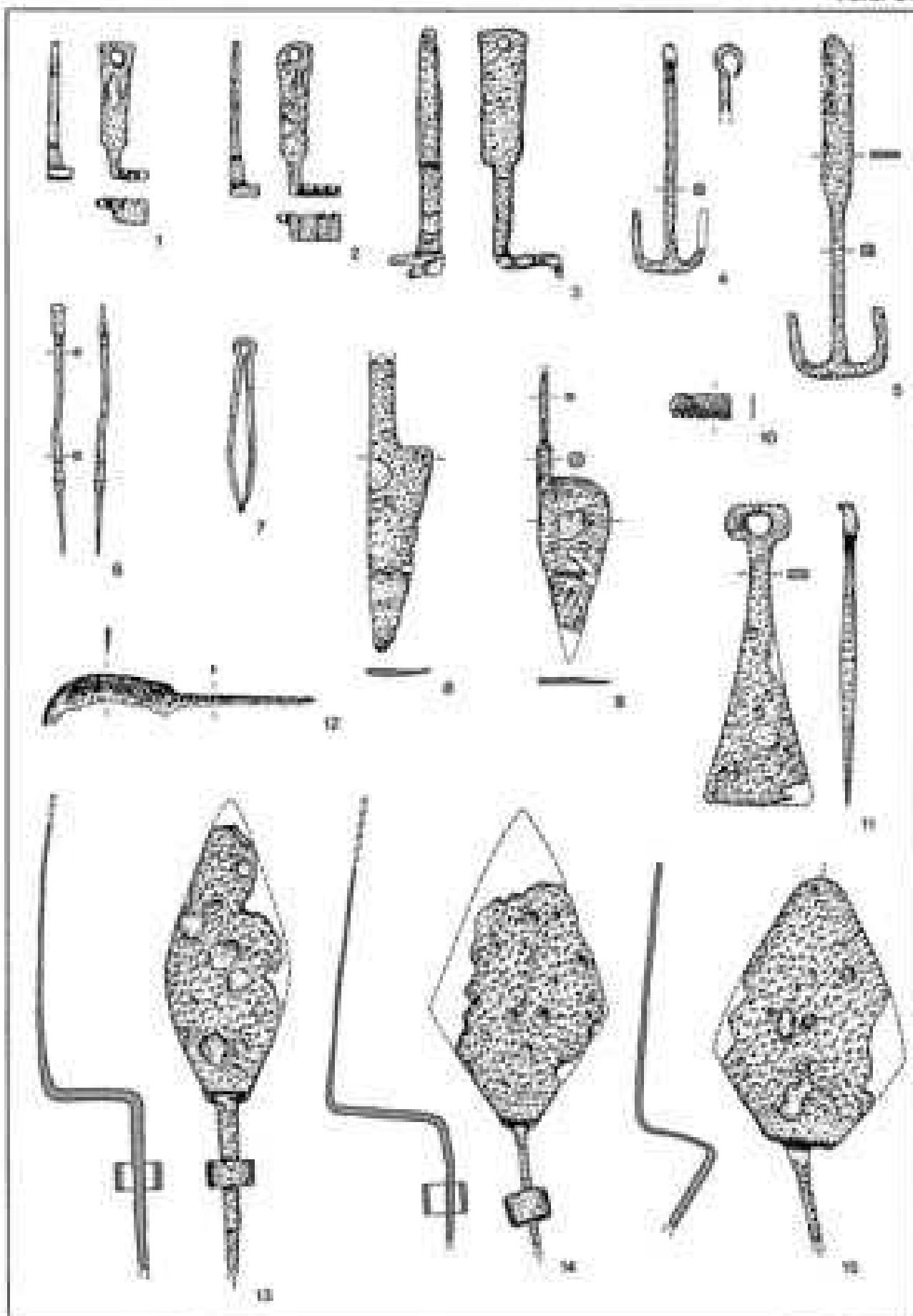

Exon. M. 1:3.

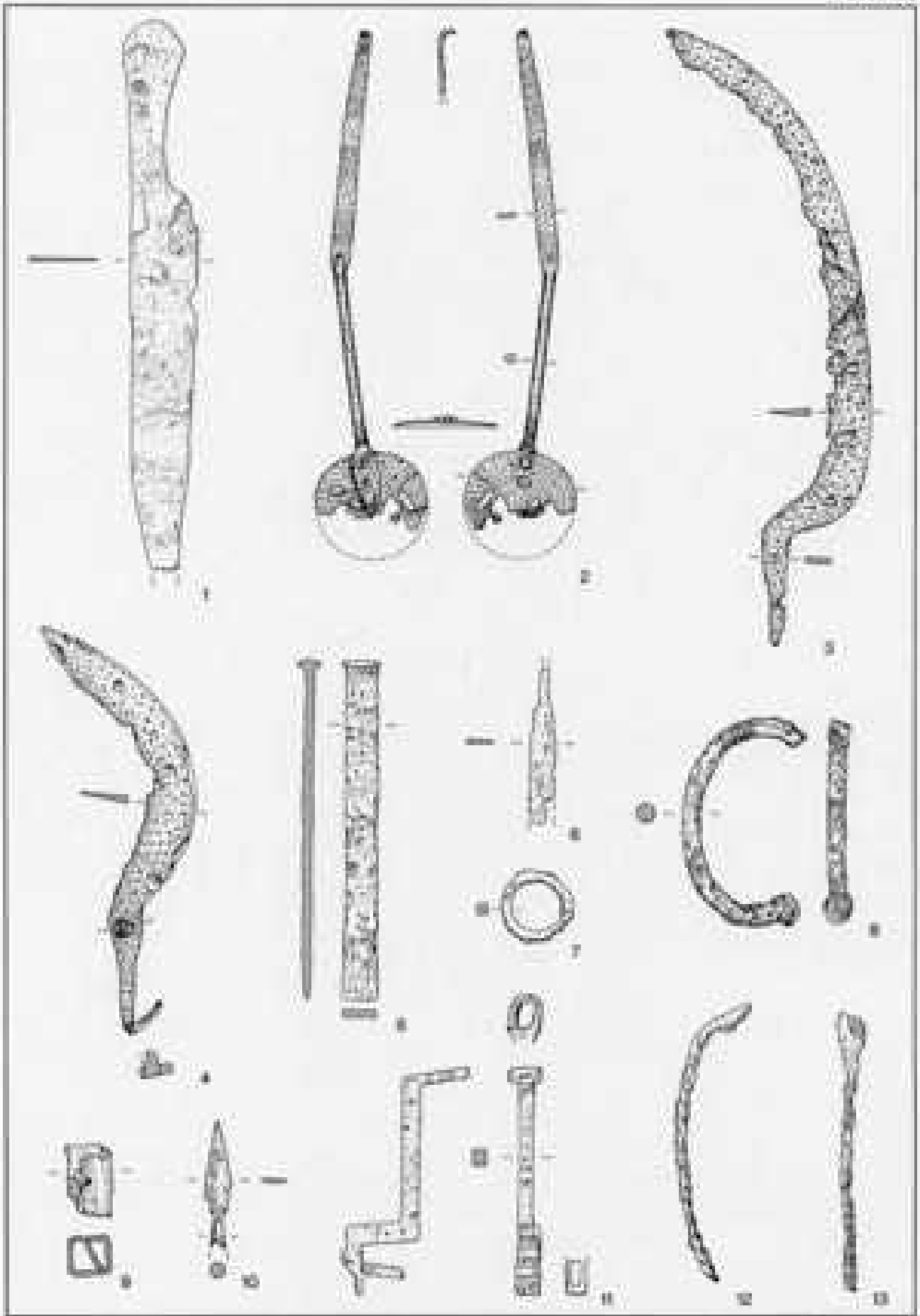

Exempl. M. 13.

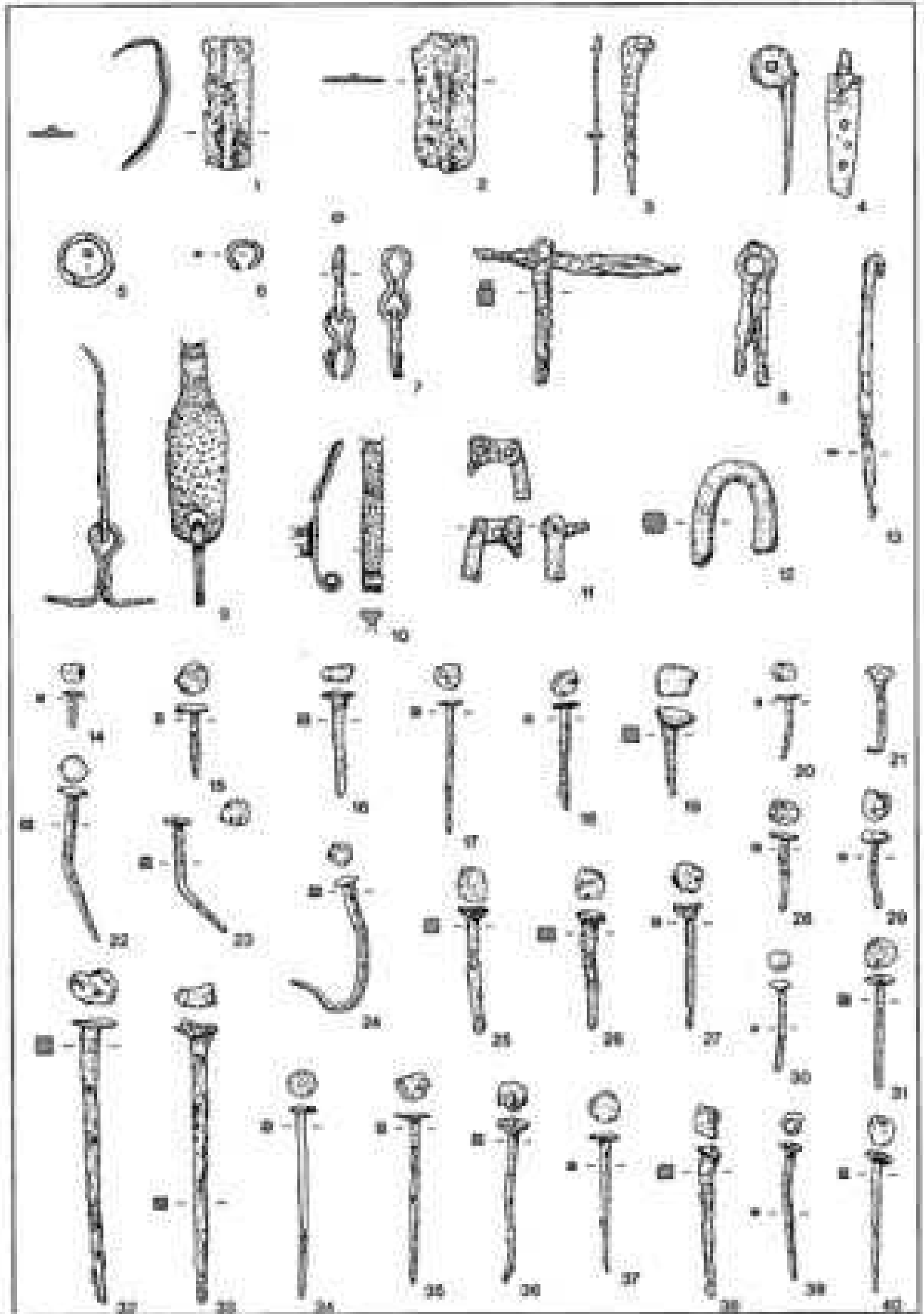

Tab. M. 13.

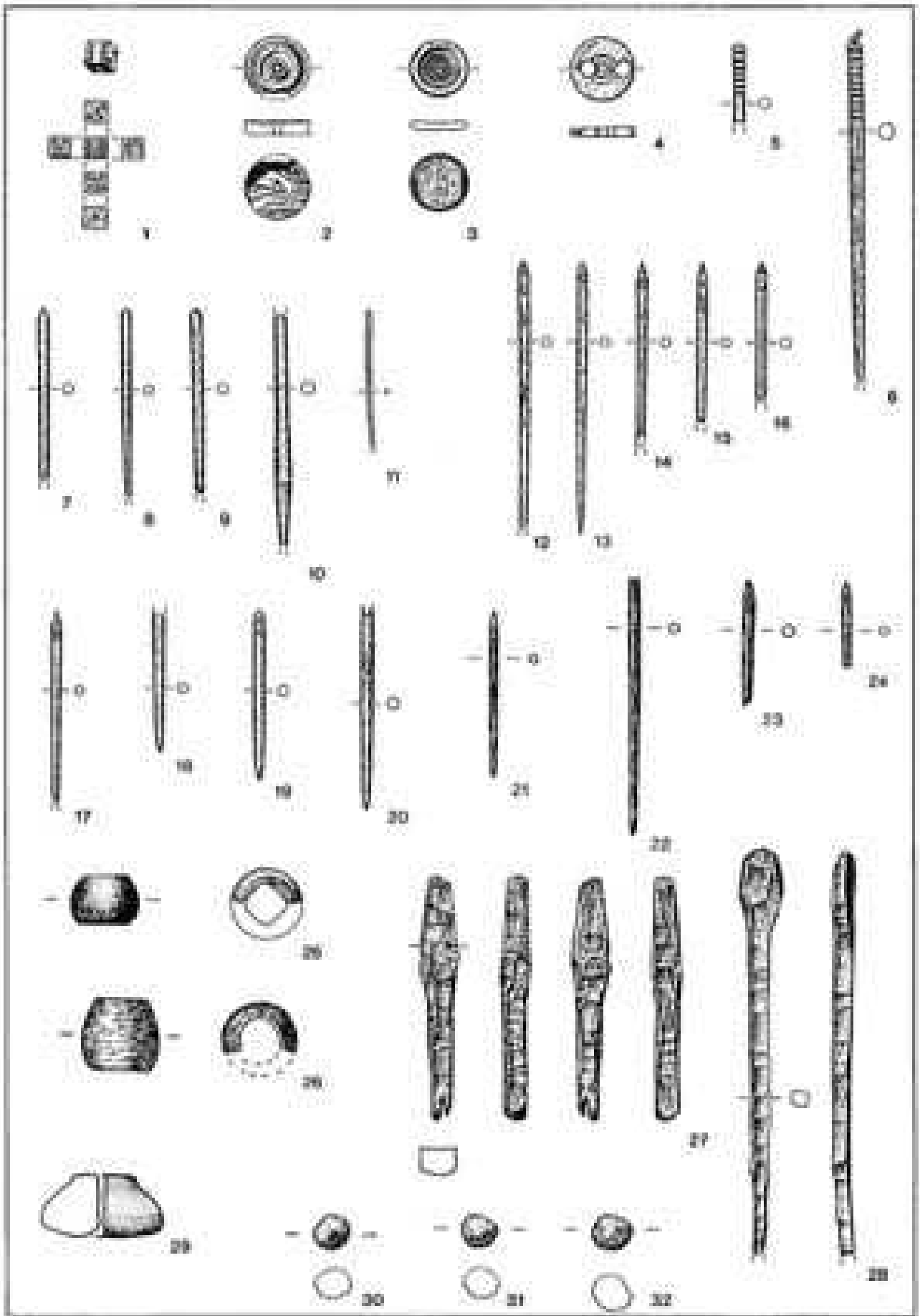

1-38 Knochen und Bein, 29 Ton, 30-32 Ägyptisch Bau. M. 1:2.

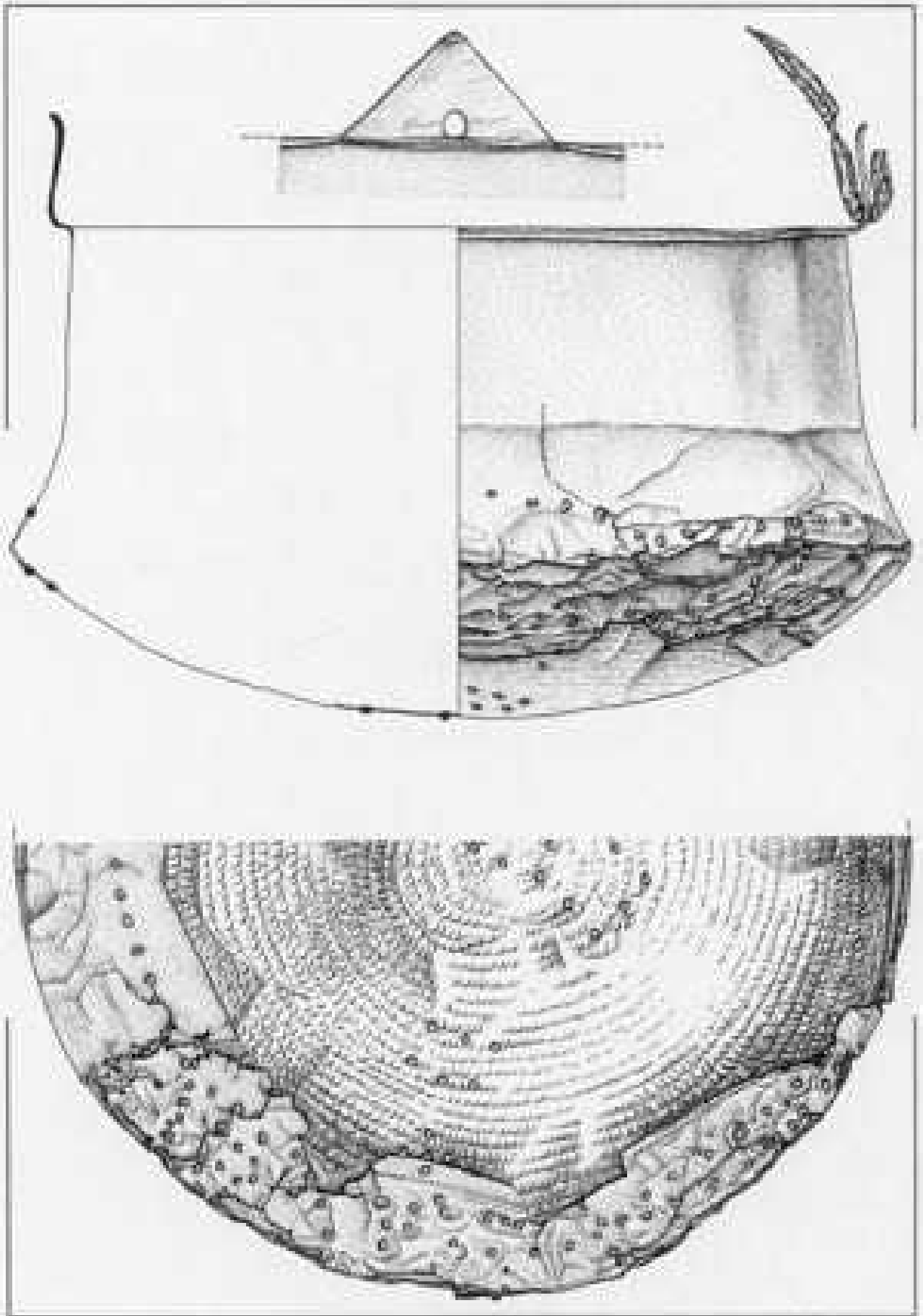

Der Hartfund, Bronzebecken, N. 1/3.

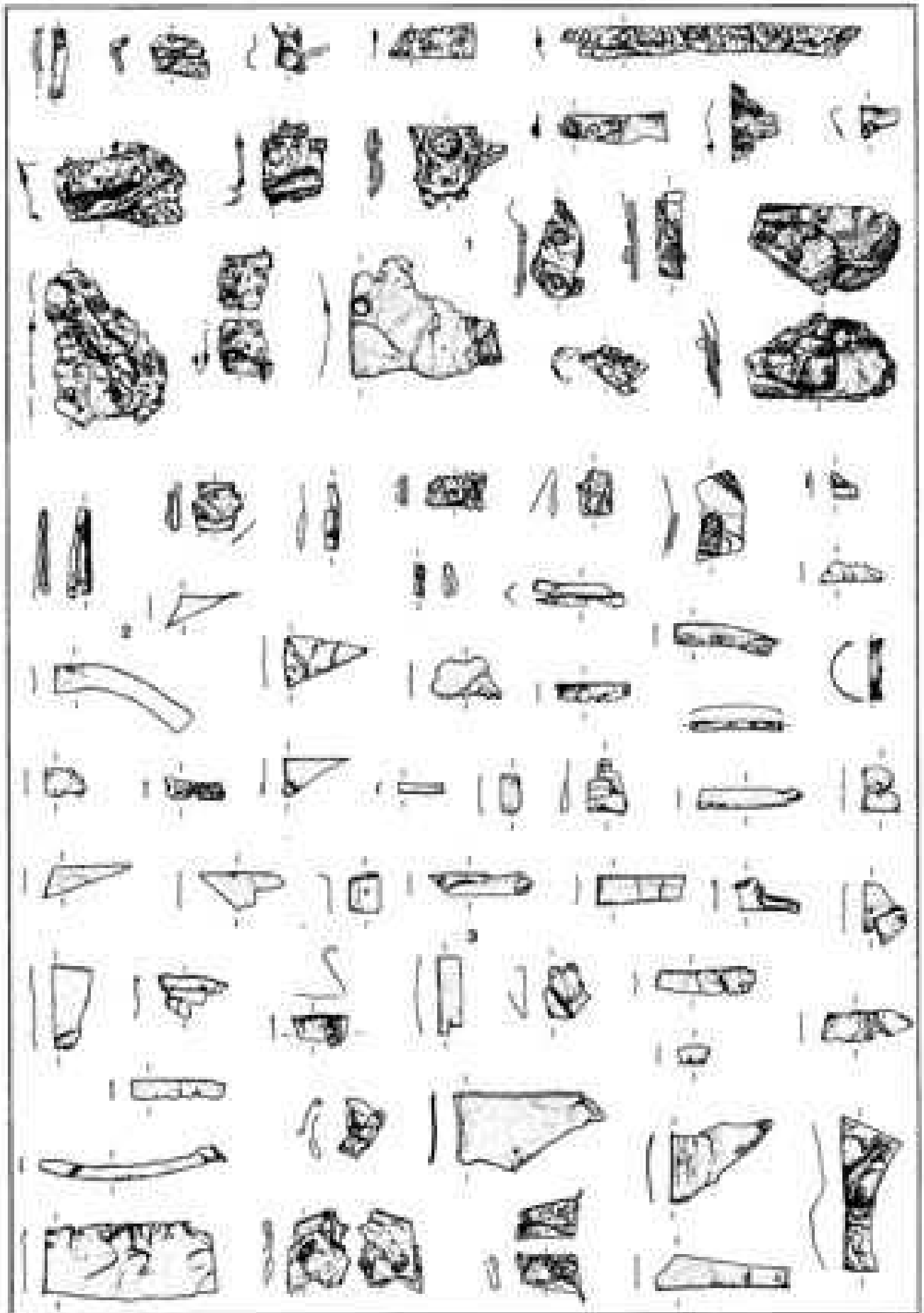

Der Hortfund: Inhalt des Bronzekeessals, Bronze. M. 1:3.

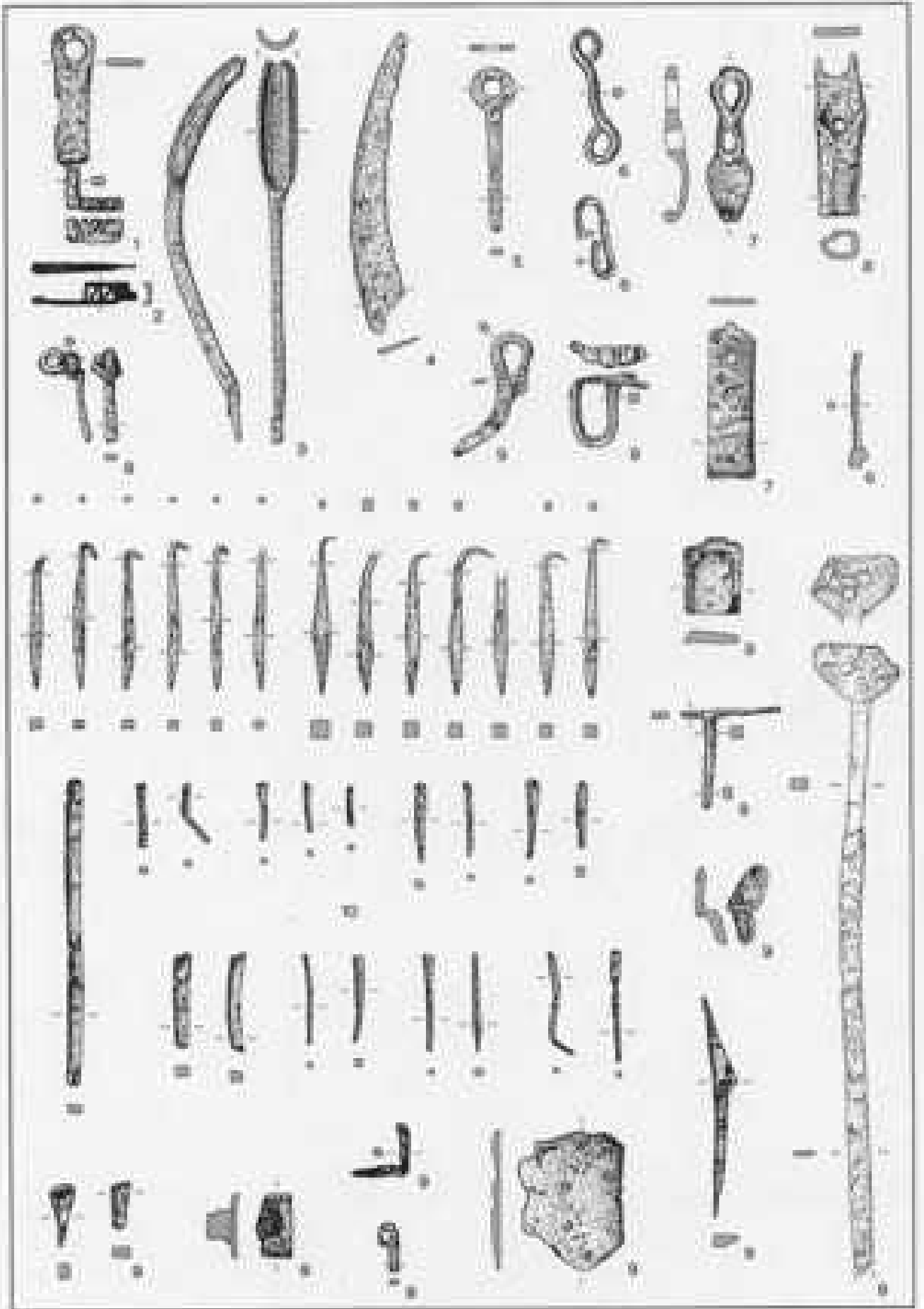

Der Kehlkopf; Inhalt des Rachenraums. Eisen. M. 1:3.

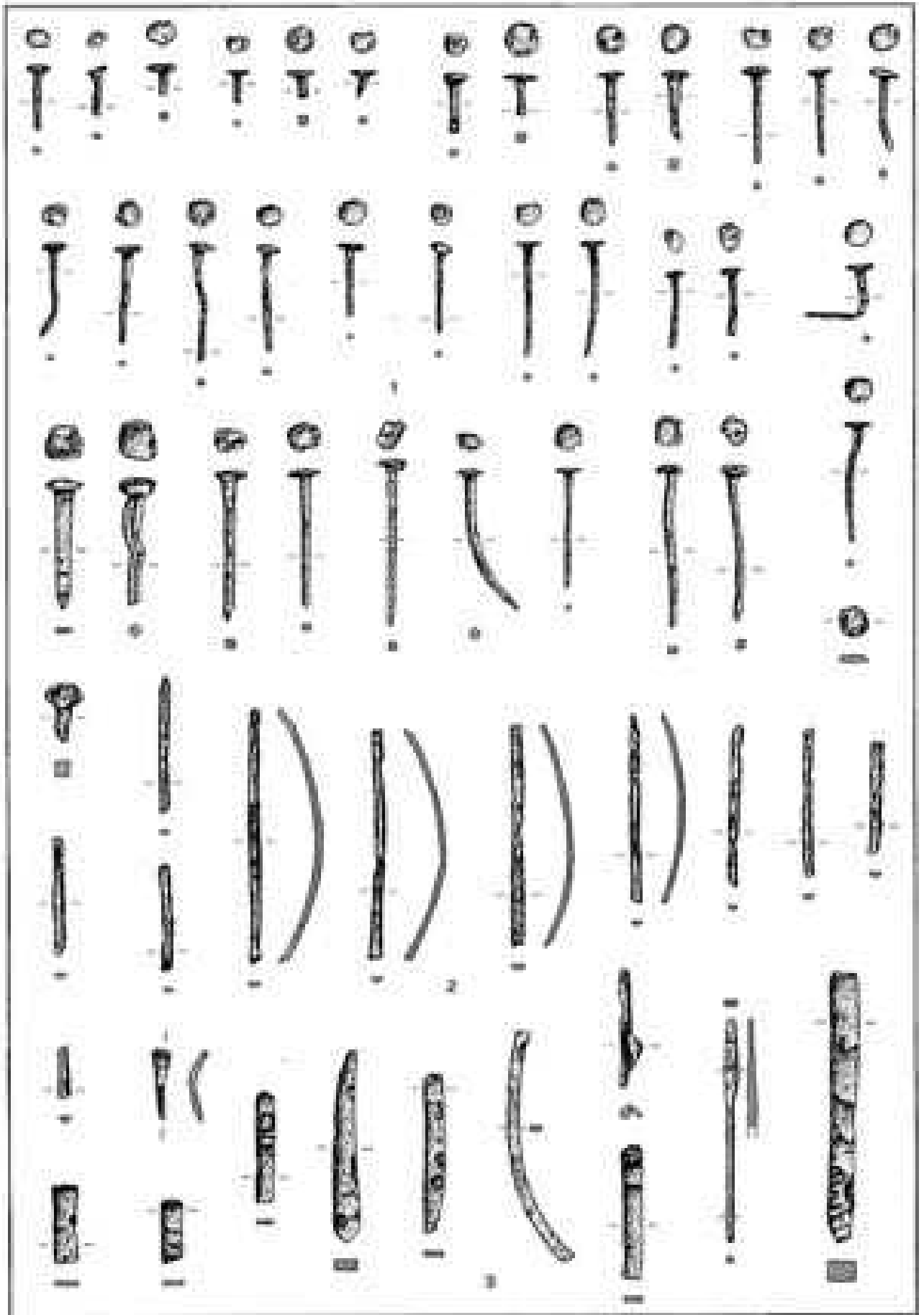

Der Horthund; Inhalt des Bronzefasses, Eisen. M. 13.

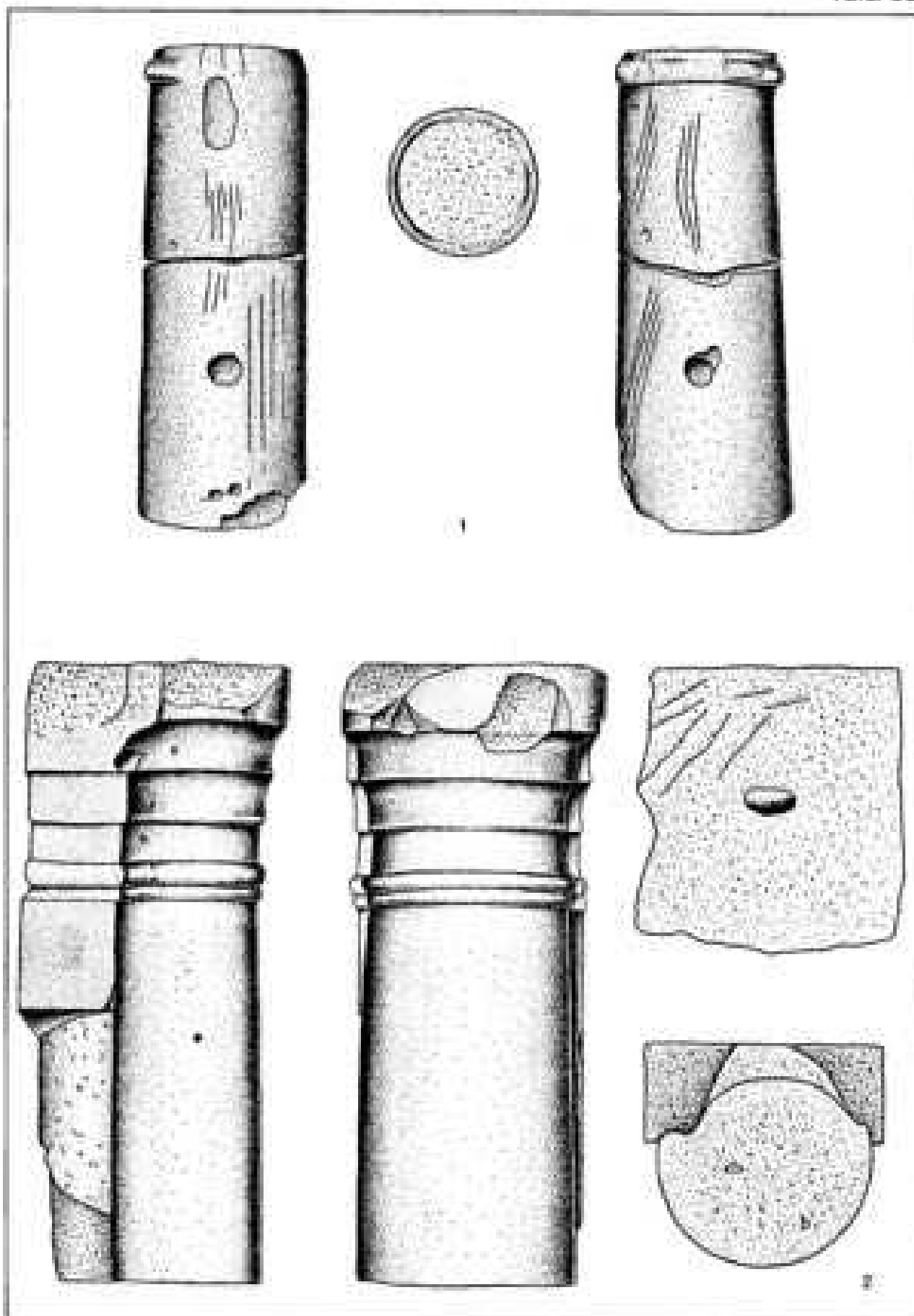

Behauener Sandstein (Architekturtafel. M. 1:10).

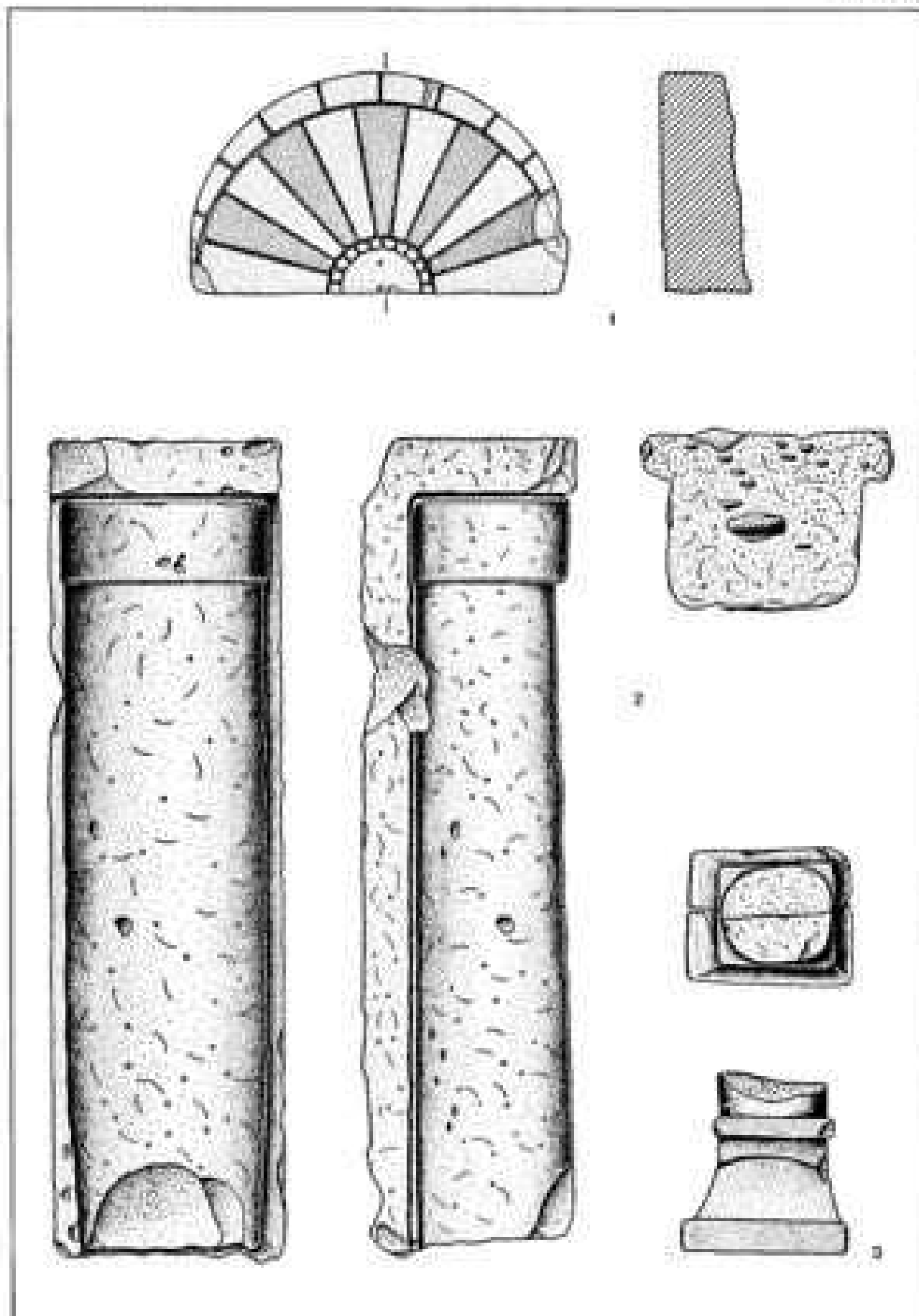

Gehauener Sandstein (Architekturspiel). M. 1:10.

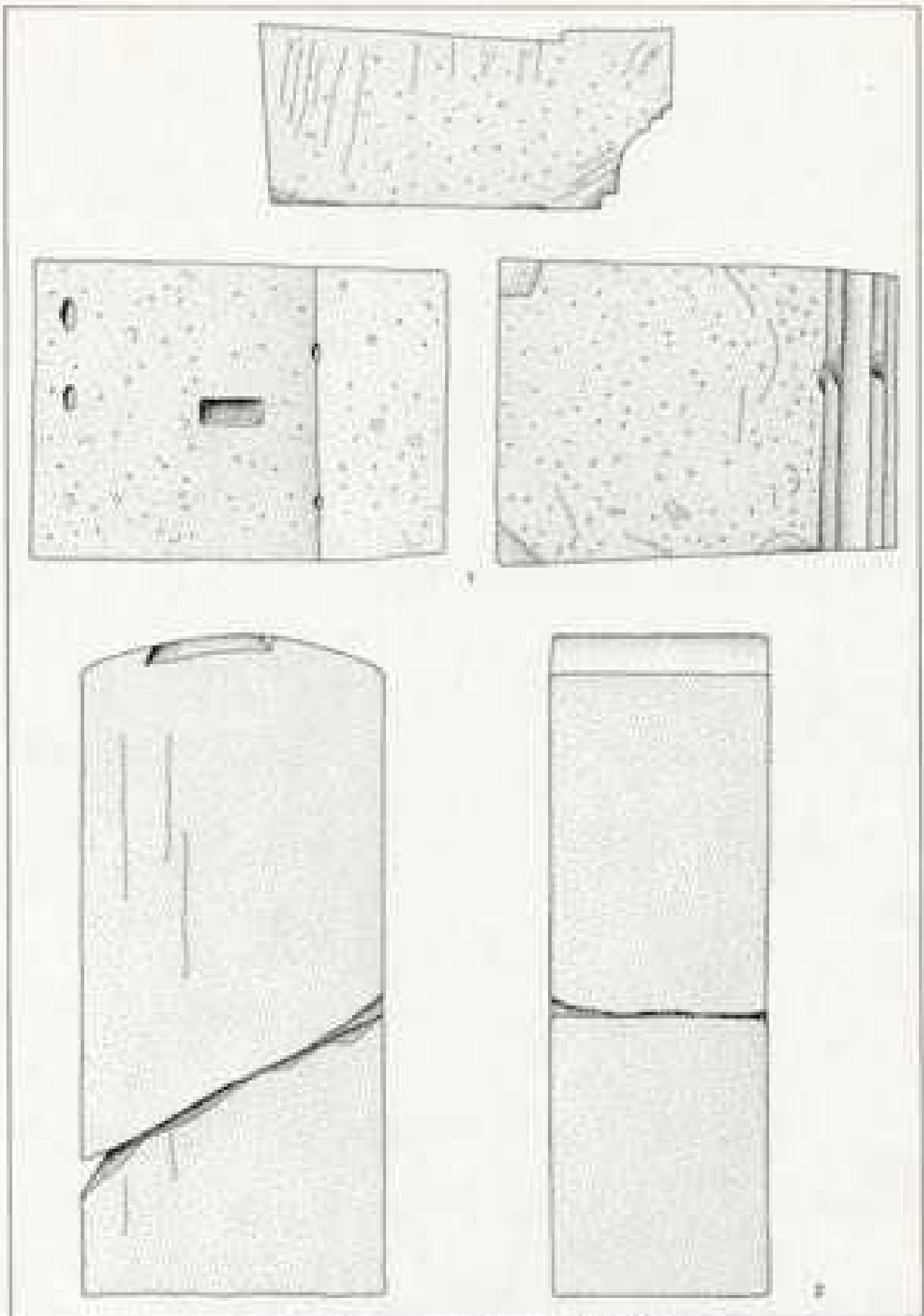

Braunauer Sandstein (Architekturrolle). M. 1:10

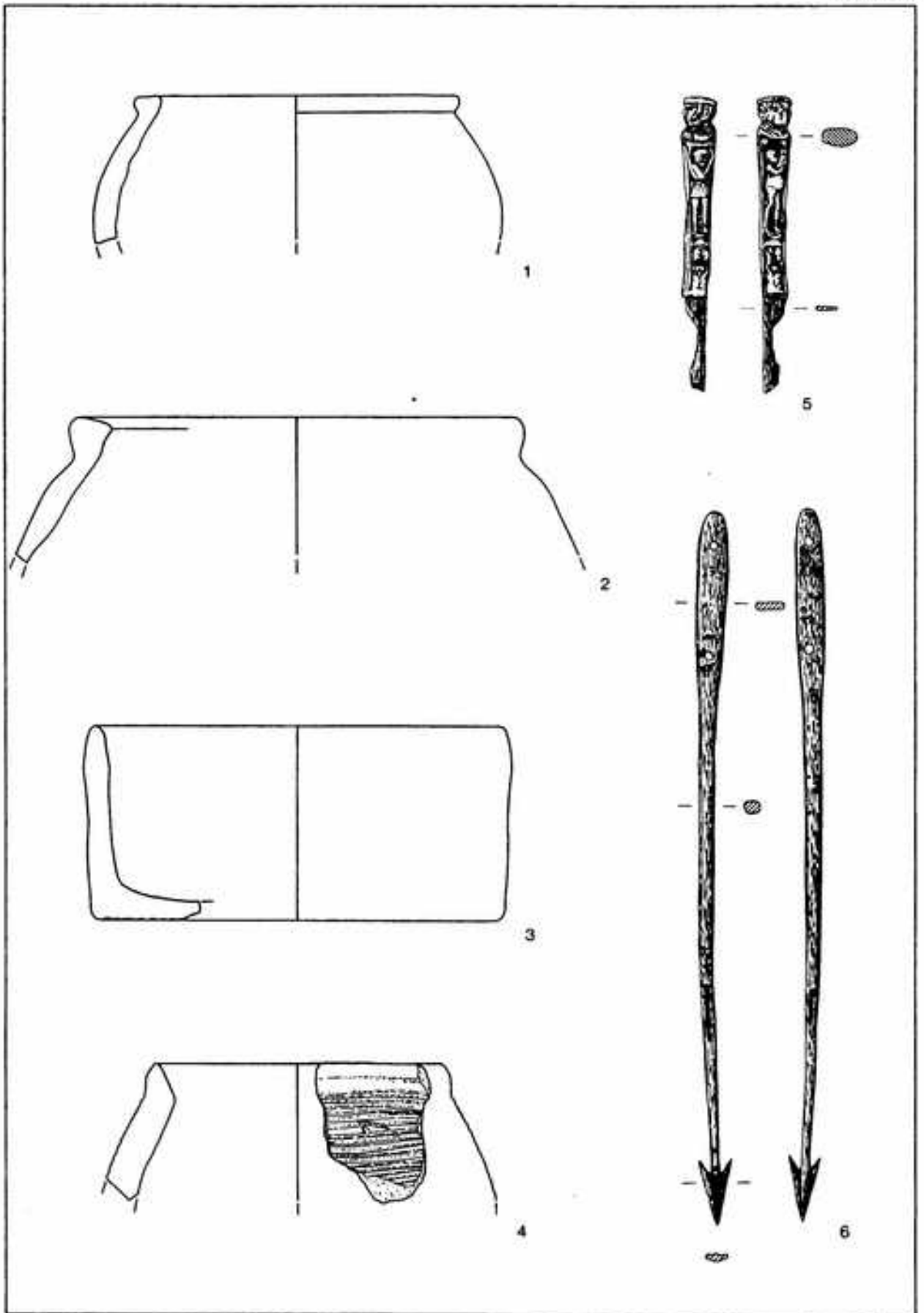

Nachrömische Funde, 1-4 Keramik, 5.6 Metall. M. 1:2.